

FORMULA SAE®

Rules 2022

Version 1.0

20 August 2021

TABLE OF CONTENTS

GR - General Regulations	5
GR.1 Formula SAE Competition Objective.....	5
GR.2 Formula SAE Rules and Organizer Authority.....	6
GR.3 Rules of Conduct.....	7
GR.4 Rules Format and Use.....	8
GR.5 Rules Questions.....	8
GR.6 Protests.....	9
GR.7 Vehicle Eligibility.....	10
AD - Administrative Regulations	11
AD.1 The Formula SAE Series.....	11
AD.2 Official Information Sources.....	11
AD.3 Individual Participation Requirements.....	11
AD.4 Individual Registration Requirements.....	12
AD.5 Team Advisors and Officers.....	12
AD.6 Competition Registration.....	14
AD.7 Competition Site.....	14
DR - Document Requirements	16
DR.1 Documentation.....	16
DR.2 Submission Details.....	16
DR.3 Submission Penalties.....	17
V - Vehicle Requirements	19
V.1 Configuration.....	19
V.2 Driver.....	20
V.3 Suspension and Steering.....	20
V.4 Wheels and Tires.....	21
F - Chassis and Structural	23
F.1 Definitions.....	23
F.2 Documentation.....	25
F.3 Tubing and Material.....	25
F.4 Composite and Other Materials.....	28
F.5 Chassis Requirements.....	30
F.6 Tube Frames.....	36
F.7 Monocoque.....	39
F.8 Front Chassis Protection.....	42
F.9 Fuel System (IC Only).....	46
F.10 Accumulator Container (EV Only).....	46
F.11 Tractive System (EV Only).....	50
T - Technical Aspects	51
T.1 Cockpit.....	51
T.2 Driver Accommodation.....	55
T.3 Brake System.....	59
T.4 Electronic Throttle Components.....	61
T.5 Powertrain.....	63
T.6 Pressurized Systems.....	65
T.7 Bodywork and Aerodynamic Devices.....	66

T.8	Fasteners	68
T.9	Electrical Equipment	68
VE	- Vehicle and Driver Equipment	71
VE.1	Vehicle Identification	71
VE.2	Vehicle Equipment	72
VE.3	Driver Equipment	73
IC	- Internal Combustion Engine Vehicles	75
IC.1	General Requirements	75
IC.2	Air Intake System	75
IC.3	Throttle	77
IC.4	Electronic Throttle Control.....	77
IC.5	Fuel and Fuel System	80
IC.6	Fuel Injection.....	82
IC.7	Exhaust and Noise Control	84
IC.8	Electrical.....	84
IC.9	Shutdown System.....	85
EV	- Electric Vehicles	86
EV.1	Definitions	86
EV.2	Documentation	86
EV.3	Work Practices	86
EV.4	Electrical Limitations	86
EV.5	Components.....	87
EV.6	Energy Storage	90
EV.7	Electrical System	94
EV.8	Shutdown System.....	97
EV.9	Charger Requirements	102
EV.10	Vehicle Operations.....	103
IN	- Technical Inspection	105
IN.1	Inspection Requirements	105
IN.2	Inspection Conduct	105
IN.3	Initial Inspection.....	106
IN.4	Electrical Technical Inspection (EV Only)	106
IN.5	Driver Cockpit Checks.....	107
IN.6	Driver Template Inspections	108
IN.7	Cockpit Template Inspections	108
IN.8	Mechanical Technical Inspection	108
IN.9	Tilt Test.....	109
IN.10	Noise and Switch Test (IC Only)	110
IN.11	Rain Test (EV Only).....	111
IN.12	Brake Test.....	111
IN.13	Inspection Approval	112
IN.14	Modifications and Repairs	112
IN.15	Reinspection.....	113
S	- Static Events.....	115
S.1	General Static.....	115
S.2	Presentation Event.....	115
S.3	Cost and Manufacturing Event.....	116

S.4	Design Event.....	120
D	- Dynamic Events	122
D.1	General Dynamic.....	122
D.2	Pit and Paddock.....	122
D.3	Driving.....	123
D.4	Flags	124
D.5	Weather Conditions	124
D.6	Tires and Tire Changes	125
D.7	Driver Limitations.....	126
D.8	Definitions	126
D.9	Acceleration Event	126
D.10	Skidpad Event.....	127
D.11	Autocross Event	129
D.12	Endurance Event	130
D.13	Efficiency Event	135
D.14	Post Endurance	137

Verify this is the current version of this document at the FSAE Online website www.fsaonline.com

REVISION SUMMARY

*Provided as a courtesy. Not a complete list. See **GR.2.6** and **GR.4.5***

- 1.0 Changes in sections: **F.5.5, F.5.10, F.7.10, F.8, F.10, F.11.2, T.9, IC.9, EV.2, EV.10.4, IN.1, IN.2, S.4.3, S.4.4**
 Selected changes: **GR.4.5, DR.3.3.1, F.4.1.4, F.4.3.1, F.4.3.7, T.1.4.2, T.1.8.2, T.2.8.3, T.2.8.6, VE.1.1.2, EV.5.3.4, EV.8.3.2, D.2.3**

GR - GENERAL REGULATIONS

GR.1 FORMULA SAE COMPETITION OBJECTIVE

GR.1.1 Collegiate Design Series

SAE International's Collegiate Design Series (CDS) programs prepare undergraduate and graduate engineering students in a variety of disciplines for future employment in mobility-related industries by challenging them with a real world, engineering application.

Through the Engineering Design Process, experiences may include but are not limited to:

- Project management, budgeting, communication, and resource management skills
- Team collaboration
- Applying industry rules and regulations
- Design, build, and test the performance of a real vehicle
- Interact and compete with other students from around the globe
- Develop and prepare technical documentation

Students also gain valuable exposure to and engagement with industry professionals to enhance 21st century learning skills, to build their own network and help prepare them for the workforce after graduation.

GR.1.2 Formula SAE Concept

The Formula SAE® competitions challenge teams of university undergraduate and graduate students to conceive, design, fabricate, develop and compete with small, formula style vehicles.

GR.1.3 Engineering Competition

Formula SAE® is an engineering education competition that requires performance demonstration of vehicles in a series of events, both off track and on track against the clock.

Each competition gives teams the chance to demonstrate their creativity and engineering skills in comparison to teams from other universities around the world.

GR.1.4 Vehicle Design Objectives

GR.1.4.1 Teams are to assume that they work for an engineering firm that is designing, fabricating, testing and demonstrating a prototype vehicle.

GR.1.4.2 The vehicle should have high performance and be sufficiently durable to successfully complete all the events at the Formula SAE competitions.

GR.1.4.3 Additional design factors include: aesthetics, cost, ergonomics, maintainability, and manufacturability.

GR.1.4.4 Each design will be judged and evaluated against other competing designs in a series of Static and Dynamic events to determine the vehicle that best meets the design goals and may be profitably built and marketed.

GR.1.5 Good Engineering Practices

Vehicles entered into Formula SAE competitions should be designed and fabricated in accordance with good engineering practices.

GR.1.6 Restriction on Vehicle Use

SAE International, competition organizer(s) and officials are not responsible for use of vehicles designed in compliance with these Formula SAE Rules outside of the official Formula SAE competitions.

GR.2 FORMULA SAE RULES AND ORGANIZER AUTHORITY

GR.2.1 Rules Authority

The Formula SAE Rules are the responsibility of the Formula SAE Rules Committee and are issued under the authority of the SAE International Collegiate Design Series.

GR.2.2 Rules Validity

GR.2.2.1 The Formula SAE Rules posted on the website and dated for the calendar year of the competition are the rules in effect for the competition.

GR.2.2.2 Rules appendices or supplements may be posted on the website and incorporated into the rules by reference.

GR.2.2.3 Additional guidance or reference documents may be posted on the website.

GR.2.2.4 Any rules, questions, or resolutions from previous years are not valid for the current competition year.

GR.2.3 Rules Alterations

GR.2.3.1 The Formula SAE rules may be revised, updated, or amended at any time during the competition season.

GR.2.3.2 Official designated announcements from the Formula SAE Rules Committee, SAE International or the other organizing bodies are to be considered part of, and have the same validity as, these rules.

GR.2.3.3 Draft rules or proposals may be issued for comments, however they are a courtesy, are not valid for any competitions, and may or may not be implemented in whole or in part.

GR.2.4 Rules Compliance

GR.2.4.1 By entering a Formula SAE competition, the team, members of the team as individuals, faculty advisors and other personnel of the entering university agree to comply with, and be bound by, these rules and all rule interpretations or procedures issued or announced by SAE International, the Formula SAE Rules Committee and the other organizing bodies.

GR.2.4.2 All participants must comply with the latest issue of the Formula SAE Rules. Refer to the FSAE Online Website to verify the current version.

GR.2.4.3 Teams and team members must comply with the general rules and any specific rules for each competition they enter.

GR.2.4.4 Any regulations pertaining to the use of the competition site by teams or individuals and which are posted, announced and/or otherwise publicly available are incorporated into the Formula SAE Rules by reference. As examples, all competition site waiver requirements, speed limits, parking and facility use rules apply to Formula SAE participants.

GR.2.5 Violations on Intent

The violation of the intent of a rule will be considered a violation of the rule itself.

GR.2.6 Understanding the Rules

Teams, team members as individuals and faculty advisors, are responsible for reading and understanding the rules in effect for the competition in which they are participating.

GR.2.7 Participating in the Competition

GR.2.7.1 Teams, individual team members, faculty advisors and other representatives of a registered university who are present onsite at a competition are “participating in the competition” from the time they arrive at the competition site until they depart the site at the conclusion of the competition or earlier by withdrawing.

GR.2.7.2 All team members, faculty advisors and other university representatives must cooperate with, and follow all instructions from, competition organizers, officials and judges.

GR.2.8 Forfeit for Non Appearance

GR.2.8.1 It is the responsibility of each team to be in the right place at the right time.

GR.2.8.2 If a team is not present and ready to compete at the scheduled time, they forfeit their attempt at that event.

GR.2.8.3 There are no makeups for missed appearances.

GR.2.9 Right to Impound

GR.2.9.1 SAE International and other competition organizing bodies may impound any onsite registered vehicle at any time during a competition.

GR.2.9.2 Team access to a vehicle in impound may be restricted.

GR.2.10 Problem Resolution

Any problems that arise during the competition will be resolved through the onsite organizers and the decision will be final.

GR.2.11 General Authority

SAE International and the competition organizing bodies reserve the right to revise the schedule of any competition and/or interpret or modify the competition rules at any time and in any manner that is, in their sole judgment, required for the efficient operation of the event or the Formula SAE series as a whole.

GR.3 RULES OF CONDUCT

GR.3.1 Unsportsmanlike Conduct

If unsportsmanlike conduct occurs, the team will receive a warning from an official.

A second violation will result in expulsion of the team from the competition.

GR.3.2 Official Instructions

Failure of a team member to follow an instruction or command directed specifically to that team or team member will result in a 25 point penalty.

GR.3.3 Arguments with Officials

Argument with, or disobedience of, any official may result in the team being eliminated from the competition.

All members of the team may be immediately escorted from the grounds.

GR.3.4 Alcohol and Illegal Material

GR.3.4.1 Alcohol, illegal drugs, weapons or other illegal material are prohibited on the competition site during the entire competition.

GR.3.4.2 Any violation of this rule by any team member or faculty advisor will cause immediate disqualification and expulsion of the entire team.

GR.3.4.3 Any use of drugs, or the use of alcohol by an underage individual will be reported to the local authorities.

GR.3.5 Smoking – Prohibited

Smoking and e-cigarette use is prohibited in all competition areas.

GR.4 RULES FORMAT AND USE

GR.4.1 Definition of Terms

- **Must** - designates a requirement
- **Must NOT** - designates a prohibition or restriction
- **Should** - gives an expectation
- **May** - gives permission, not a requirement and not a recommendation

GR.4.2 Capitalized Terms

Items or areas which have specific definitions or are covered by specific rules are capitalized.

For example, “Rules Questions” or “Primary Structure”

GR.4.3 Headings

The article, section and paragraph headings in these rules are provided only to facilitate reading: they do not affect the paragraph contents.

GR.4.4 Applicability

GR.4.4.1 Unless otherwise designated, all rules apply to all vehicles at all times

GR.4.4.2 Rules specific to vehicles based on their powertrain will be designated as such in the rule text:

- Internal Combustion “IC” or “IC Only”
- Electric Vehicle “EV” or “EV Only”

GR.4.5 Figures and Illustrations

Figures and illustrations give clarification or guidance, but are rules only when referred to in the text of a rule

GR.4.6 Change Identification

Any summary of changed rules and/or changed portions marked in the rules themselves are provided for courtesy, and may or may not include all changes.

GR.5 RULES QUESTIONS

GR.5.1 Question Types

Designated officials will answer questions that are not already answered in the rules or FAQs or that require new or novel rule interpretations.

Rules Questions may also be used to request approval, as designated in these rules.

GR.5.2 Question Format

GR.5.2.1 All Rules Questions must include:

- Full name and contact information of the person submitting the question
- University name – no abbreviations
- The specific competition your team has, or is planning to, enter.
- Number of the applicable rule(s)

GR.5.2.2 Response Time

- Please allow a minimum of two weeks for a response
- Do not resubmit questions

GR.5.2.3 Submission Addresses

- a. Teams entering Formula SAE competitions: Follow the link and instructions published on the FSAE Online Website to "Submit a Rules Question"
- b. Teams entering other competitions please visit those respective competition websites for further instructions.

GR.5.3 Question Publication

Any submitted question and the official answer may be reproduced and freely distributed, in both complete and edited versions.

GR.6 PROTESTS

GR.6.1 Cause for Protest

A team may protest any rule interpretation, score or official action (unless specifically excluded from Protest) which they feel has caused some actual, non trivial, harm to their team, or has had a substantive effect on their score.

GR.6.2 Preliminary Review – Required

Questions about scoring, judging, policies or any official action must be brought to the attention of the organizer or SAE International staff for an informal preliminary review before a protest may be filed.

GR.6.3 Protest Format

- All protests must be filed in writing
- The completed protest must be presented to the organizer or SAE International staff by the team captain.
- Team video or data acquisition will not be reviewed as part of a protest.

GR.6.4 Protest Point Bond

A team must post a 25 point protest bond which will be forfeited if their protest is rejected.

GR.6.5 Protest Period

Protests concerning any aspect of the competition must be filed in the protest period announced by the competition organizers or 30 minutes of the posting of the scores of the event to which the protest relates.

GR.6.6 Decision

The decision regarding any protest is final.

GR.7 VEHICLE ELIGIBILITY

GR.7.1 Student Developed Vehicle

GR.7.1.1 Vehicles entered into Formula SAE competitions must be conceived, designed, fabricated and maintained by the student team members without direct involvement from professional engineers, automotive engineers, racers, machinists or related professionals.

GR.7.1.2 Information Sources

The student team may use any literature or knowledge related to design and information from professionals or from academics as long as the information is given as a discussion of alternatives with their pros and cons.

GR.7.1.3 Professional Assistance

Professionals must not make design decisions or drawings. The Faculty Advisor may be required to sign a statement of compliance with this restriction.

GR.7.1.4 Student Fabrication

Students should perform all fabrication tasks

GR.7.2 Definitions

GR.7.2.1 Competition Year

The period beginning at the event of the Formula SAE series where the vehicle first competes and continuing until the start of the corresponding event held approximately 12 months later.

GR.7.2.2 First Year Vehicle

A vehicle which has, at minimum, a newly built chassis and is in its initial Competition Year

GR.7.2.3 Second Year Vehicle

A vehicle which has competed in a previous Competition Year

GR.7.2.4 Third Year Vehicle

A vehicle which has competed in more than one previous Competition Year

GR.7.3 Formula SAE Competition Eligibility

GR.7.3.1 Only First Year Vehicles may enter the Formula SAE Competitions.

- a. If there is any question about the status as a First Year Vehicle, the team must provide additional information and/or evidence.

GR.7.3.2 Second Year Vehicles must not enter Formula SAE Competitions, unless permitted by the organizer of the specific competition.

GR.7.3.3 Third Year Vehicles must not enter any Formula SAE Competitions

AD - ADMINISTRATIVE REGULATIONS

AD.1 THE FORMULA SAE SERIES

AD.1.1 Rule Variations

All competitions in the Formula SAE Series may post rule variations specific to the operation of the events in their countries. Vehicle design requirements and restrictions will remain unchanged. Any rule variations will be posted on the websites specific to those competitions.

AD.1.2 Official Announcements and Competition Information

Teams must read the published announcements by SAE International and the other organizing bodies and be familiar with all official announcements concerning the competitions and any released rules interpretations.

AD.1.3 Official Languages

The official language of the Formula SAE series is English.

Document submissions, presentations and discussions in English are acceptable at all competitions in the series.

AD.2 OFFICIAL INFORMATION SOURCES

The following websites are referenced in these rules. Refer to the websites for additional information and resources.

AD.2.1 Event Website

The Event Website for Formula SAE is specific to each competition, refer to:

<https://www.sae.org/attend/student-events>

AD.2.2 FSAE Online Website

The FSAE Online website is at: <http://fsaeonline.com/>

AD.2.2.1 Documents, forms, and information are accessed from the “Series Resources” link

AD.2.2.2 Each registered team must have an account on the FSAE Online Website.

AD.2.2.3 Each team must have one or more persons as Team Captain. The Team Captain must accept Team Members.

AD.2.2.4 Only persons designated Team Members or Team Captains are able to upload documents to the website.

AD.2.3 Contacts

Contact collegiatecompetitions@sae.org with any problems/comments/concerns

Consult the specific website for the other competitions requirements.

AD.3 INDIVIDUAL PARTICIPATION REQUIREMENTS

AD.3.1 Eligibility

AD.3.1.1 Team members must be enrolled as degree seeking undergraduate or graduate students in the college or university of the team with which they are participating.

AD.3.1.2 Team members who have graduated during the seven month period prior to the competition remain eligible to participate.

AD.3.1.3 Teams which are formed with members from two or more universities are treated as a single team. A student at any university making up the team may compete at any competition where the team participates. The multiple universities are treated as one university with the same eligibility requirements.

AD.3.1.4 Each team member may participate at a competition for only one team. This includes competitions where the University enters both IC and EV teams.

AD.3.2 Age

Team members must be minimum 18 years of age.

AD.3.3 Driver's License

Team members who will drive a competition vehicle at any time during a competition must hold a valid, government issued driver's license.

AD.3.4 Society Membership

Team members must be members of one or more of the following societies: SAE International, SAE Australasia, SAE Brazil, IMechE, VDI, or JSAE.

Proof of membership, such as membership card, is required at the competition.

AD.3.5 Medical Insurance

Individual medical insurance coverage is required and is the sole responsibility of the participant.

AD.3.6 Disabled Accessibility

Team members who require accessibility for areas outside of ADA Compliance must contact organizers at collegiatecompetitions@sae.org prior to start of competition.

AD.4 INDIVIDUAL REGISTRATION REQUIREMENTS

AD.4.1 Preliminary Registration

AD.4.1.1 All students and faculty must be affiliated to your respective school /college/university on the Event Website by January 31 of the year of the competition.

AD.4.1.2 International student participants (or unaffiliated Faculty Advisors) who are not SAE International members must create a free customer account profile on www.sae.org. Upon completion, please email collegiatecompetitions@sae.org the assigned customer number stating also the event and university affiliation.

AD.4.2 Onsite Registration

AD.4.2.1 All team members and faculty advisors must register at the competition site

AD.4.2.2 All onsite participants, including students, faculty and volunteers, must sign a liability waiver upon registering onsite.

AD.4.2.3 Onsite registration must be completed before the vehicle may be unloaded, uncrated or worked upon in any manner.

AD.5 TEAM ADVISORS AND OFFICERS

AD.5.1 Faculty Advisor

AD.5.1.1 Each team must have a Faculty Advisor appointed by their university.

AD.5.1.2 The Faculty Advisor should accompany the team to the competition and will be considered by the officials to be the official university representative.

AD.5.1.3 Faculty Advisors:

- a. May advise their teams on general engineering and engineering project management theory.
- b. Must not design, build or repair any part of the vehicle
- c. Must not develop any documentation or presentation

AD.5.2 Electrical System Officer (EV Only)

The Electrical System Officer (ESO) is responsible for all electrical operations of the vehicle during the event.

AD.5.2.1 Every participating team must appoint one or more ESO for the event

AD.5.2.2 The ESO must meet the following:

- a. Is a valid team member, see **AD.3 Individual Participation Requirements**
- b. One or more ESO must not be a driver.
- c. Is certified or has received appropriate practical training whether formal or informal for working with High Voltage systems in automotive vehicles.

Details of the training must be provided to the organizers on the ESO/ESA form for approval.

AD.5.2.3 Duties of the ESO - see **EV.3.1.1**

AD.5.3 Electric System Advisor (EV Only)

AD.5.3.1 The Electrical System Advisor (ESA) must be a professionally competent person(s) nominated by the team who can advise on the electrical and control systems that will be integrated into the vehicle. The faculty advisor may also be the ESA if all the requirements below are met.

AD.5.3.2 The ESA must supply details of their experience of electrical and/or control systems engineering as used in the vehicle on the ESO/ESA form for approval by the organizers.

AD.5.3.3 The ESA must be sufficiently qualified to advise the team on their proposed electrical and control system designs based on significant experience of the technology being developed and its implementation into vehicles or other safety critical systems. More than one person may be needed.

AD.5.3.4 The ESA must advise the team on the merits of any relevant engineering solutions. Solutions should be discussed, questioned and approved before they are implemented into the final vehicle design.

AD.5.3.5 The ESA should advise the students on any required training to work with the systems on the vehicle.

AD.5.3.6 The ESA must review the Electrical System Form and to confirm that in principle the vehicle has been designed using good engineering practices.

AD.5.3.7 The ESA must ensure that the team communicates any unusual aspects of the design to the organizers to reduce the risk of exclusion or significant changes being required to pass Technical Inspection.

AD.6 COMPETITION REGISTRATION

AD.6.1 General Information

AD.6.1.1 Registration for Formula SAE competitions must be completed on the Event Website.

AD.6.1.2 Refer to the individual competition websites for registration requirements for other competitions

AD.6.2 Registration Details

AD.6.2.1 Refer to the Event Website for specific registration requirements and details.

- Registration limits and Waitlist limits will be posted on the Event Website.
- Registration will open at the date and time posted on the Event Website.
- Registration(s) may have limitations

AD.6.2.2 Once a competition reaches the registration limit, a Waitlist will open.

AD.6.2.3 Beginning on the date and time posted on the Event Website, any remaining slots will be available to any team on a first come, first serve basis.

AD.6.2.4 Registration and the Waitlist will close at the date and time posted on the Event Website or when all available slots have been taken, whichever occurs first.

AD.6.3 Registration Fees

AD.6.3.1 Registration fees must be paid to the organizer by the deadline specified on the respective competition website.

AD.6.3.2 Registration fees are not refundable and not transferrable to any other competition.

AD.6.4 Waitlist

AD.6.4.1 Waitlisted teams must submit all documents by the same deadlines as registered teams to remain on the Waitlist.

AD.6.4.2 Once a team withdraws from the competition, the organizer will inform the next team on the Waitlist by email (the individual who registered the team to the Waitlist) that a spot on the registered list has opened.

AD.6.4.3 The team will then have 24 hours to accept or reject the position and an additional 24 hours to have the registration payment completed or in process.

AD.6.5 Withdrawals

Registered teams that will not attend the competition must inform the organizer, as posted on the Event Website.

AD.7 COMPETITION SITE

AD.7.1 Personal Vehicles

Personal cars and trailers must be parked in designated areas only. Only authorized vehicles will be allowed in the track areas.

AD.7.2 Motorcycles, Bicycles, Rollerblades, etc. - Prohibited

The use of motorcycles, quads, bicycles, scooters, skateboards, rollerblades or similar person-carrying devices by team members and spectators in any part of the competition area, including the paddocks, is prohibited.

AD.7.3 Self-propelled Pit Carts, Tool Boxes, etc. - Prohibited

The use of self-propelled pit carts, tool boxes, tire carriers or similar motorized devices in any part of the competition site, including the paddocks, is prohibited.

AD.7.4 Trash Cleanup

AD.7.4.1 Cleanup of trash and debris is the responsibility of the teams.

- The team's work area should be kept uncluttered
- At the end of the day, each team must clean all debris from their area and help with maintaining a clean paddock

AD.7.4.2 Teams must remove all of their material and trash when leaving the site at the end of the competition.

AD.7.4.3 Teams that abandon furniture, or that leave a paddock that requires special cleaning, will be billed for removal and/or cleanup costs.

DR - DOCUMENT REQUIREMENTS

DR.1 DOCUMENTATION

DR.1.1 Requirements

- DR.1.1.1 The documents supporting each vehicle must be submitted by the deadlines posted on the Event Website or otherwise published by the organizer.
- DR.1.1.2 The procedures for submitting documents are published on the Event Website or otherwise identified by the organizer.

DR.1.2 Definitions

DR.1.2.1 Submission Date

The date and time of upload to the website

DR.1.2.2 Submission Deadline

The date and time by which the document must be uploaded or submitted

DR.1.2.3 No Submissions Accepted After

The last date and time that documents may be uploaded or submitted

DR.1.2.4 Late Submission

- Uploaded after the Submission Deadline and prior to No Submissions Accepted After
- Submitted largely incomplete prior to or after the Submission Deadline

DR.1.2.5 Not Submitted

- Not uploaded prior to No Submissions Accepted After
- Not in the specified form or format

DR.1.2.6 Amount Late

The number of days between the Submission Deadline and the Submission Date.

Any partial day is rounded up to a full day.

Examples: submitting a few minutes late would be one day penalty; submitting 25 hours late would be two days penalty

DR.1.2.7 Reviewer

A designated event official who is assigned to review and accept a Submission

DR.2 SUBMISSION DETAILS

DR.2.1 Submission Location

Teams entering Formula SAE competitions in North America must upload the required documents to the team account on the FSAE Online Website, see [AD.2.2](#)

DR.2.2 Submission Format Requirements

Refer to Table DR-1 Submission Information

DR.2.2.1 Template files with the required format must be used when specified in Table DR-1

DR.2.2.2 Template files are available on the FSAE Online Website, see [AD.2.2.1](#)

DR.2.2.3 Do Not alter the format of any provided template files

DR.2.2.4 Each submission must be one single file in the specified format (PDF - Portable Document File, XLSX - Microsoft Excel Worksheet File)

DR.3 SUBMISSION PENALTIES

DR.3.1.1 Each team is responsible for confirming that their documents have been properly uploaded or submitted and that the deadlines have been met.

DR.3.1.2 Prior to the Submission Deadline:

- a. Documents may be uploaded at any time
- b. Uploads may be replaced with new uploads without penalty

DR.3.1.3 If a Submitted Document revision is requested by the Reviewer, a new Submission Deadline for the revised document may apply

DR.3.1.4 Teams will not be notified if a document is submitted incorrectly.

DR.3.2 Penalty Detail

DR.3.2.1 Late Submissions will receive a point penalty as shown in Table DR-2, subject to official discretion.

DR.3.2.2 Additional penalties will apply if **Not Submitted**, subject to official discretion

DR.3.2.3 Penalties up to and including Removal of Team Entry may apply based on document reviews, subject to official discretion

DR.3.3 Removal of Team Entry

DR.3.3.1 The organizer may remove the team entry when the:

- a. Identified documents are **Not Submitted** in 5 days or less from the deadline. Removals will take place after each Document Submission deadline.
- b. Team does not respond to Reviewer requests or organizer communications

DR.3.3.2 When a team entry will be removed:

- a. The team will be notified prior to cancelling registration.
- b. No refund of entry fees will be given.

DR.3.4 Specific Penalties

DR.3.4.1 Electronic Throttle Control (ETC) (IC Only)

- a. There is no point penalty for ETC documents.
- b. The team will not be allowed to run ETC on their vehicle and must use mechanical throttle operation when:
 - The ETC Notice of Intent is **Not Submitted**
 - The ETC FMEA is **Not Submitted**, or is not accepted

DR.3.4.2 Fuel Type **IC.5.1**

There is no point penalty for a late fuel type order. Once the deadline has passed, the team will be allocated the basic fuel type.

DR.3.4.3 Program Submissions

Please submit material requested for the Event Program by the published deadlines.

Table DR-1 Submission Information

Submission	Refer to:	Required Format:	Submit in File Format:	Penalty Group
Structural Equivalency Spreadsheet (SES) as applicable to your design	F.2.1	see below	XLSX	Tech
ETC - Notice of Intent	IC.4.3	see below	PDF	ETC
ETC - Failure Modes and Effects Analysis (FMEA)	IC.4.3	see below	XLSX	ETC
EV – Electrical Systems Officer and Electrical Systems Advisor Form	AD.5.2, AD.5.3	see below	PDF	Tech
EV - Electrical System Form (ESF)	EV.2.1	see below	XLSX	Tech
Presentation (if required, see S.2.4.1)	S.2.4	see S.2.4	see S.2.4	Present
Cost Report	S.3.4	see S.3.4.2	(1)	Cost
Cost eBOM	S.3.5	see below see S.3.5	XLSX	Cost
Cost Addendum	S.3.7	see below	see S.3.7	none
Design Briefing	S.4.3	see below	PDF	Design
Vehicle Drawings	S.4.4	see S.4.4.1	PDF	Design
Design Spec Sheet	S.4.5	see below	XLSX	Design

Format: Use the template file or form available on the FSAE Online Website **AD.2.2.1**

Note (1): Refer to the FSAE Online website for submission requirements

Table DR-2 Submission Penalty Information

Penalty Group	Penalty Points per Day	Maximum Point Penalty	Not Submitted 5 Days after the Deadline
Tech	-10	-50	Removal of Team Entry - see DR.3.3
ETC	Not Approved to use ETC - see DR.3.4.1		
Present	-10	-50	Removed from Presentation Event Score 0 points in Presentation Event
Cost	-10	-50	Removed from Cost Event Score -100 points in Cost Event
Design	-10	-50	Removed from Design Event Score 0 points in Design Event

V - VEHICLE REQUIREMENTS

V.1 CONFIGURATION

The vehicle must be open wheeled and open cockpit (a formula style body) with four wheels that are not in a straight line.

V.1.1 Open Wheel

Open Wheel vehicles must satisfy all of the following criteria:

- The top 180° of the wheels/tires must be unobstructed when viewed from vertically above the wheel.
- The wheels/tires must be unobstructed when viewed from the side.
- No part of the vehicle may enter a keep out zone defined by two lines extending vertically from positions 75 mm in front of and 75 mm behind, the outer diameter of the front and rear tires in the side view elevation of the vehicle, with tires steered straight ahead. This keep out zone will extend laterally from the outside plane of the wheel/tire to the inboard plane of the wheel/tire.

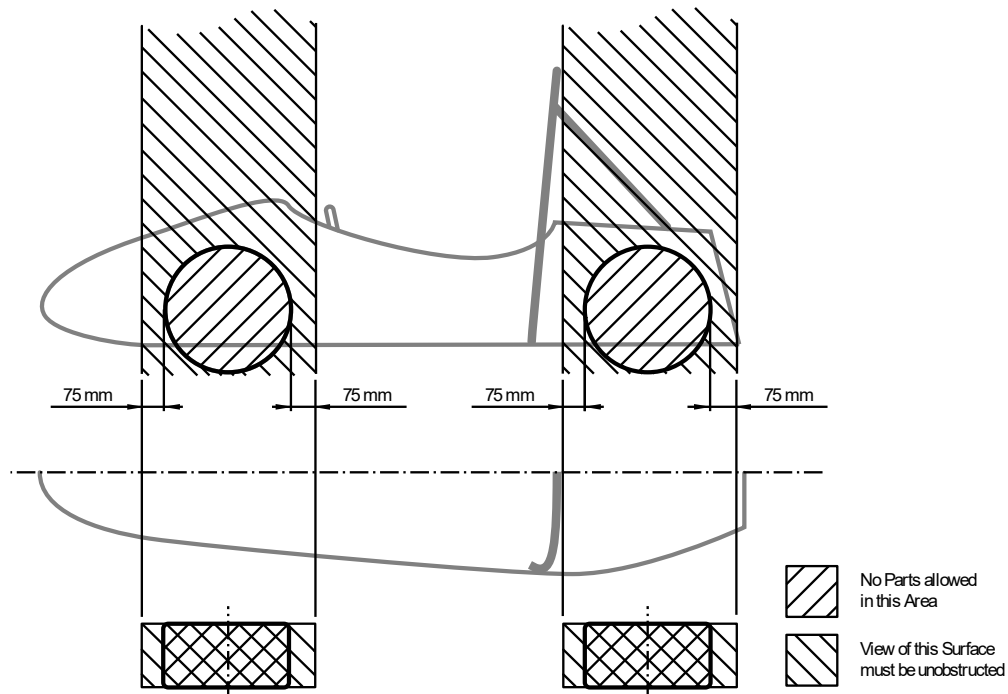

V.1.2 Wheelbase

The vehicle must have a minimum wheelbase of 1525 mm

V.1.3 Vehicle Track

V.1.3.1 The track and center of gravity must combine to provide sufficient rollover stability. See [IN.9.2](#)

V.1.3.2 The smaller track of the vehicle (front or rear) must be no less than 75% of the larger track.

V.1.4 Ground Clearance

- V.1.4.1 Ground clearance must be sufficient to prevent any portion of the vehicle except the tires from touching the ground during dynamic events.
- V.1.4.2 Intentional or excessive ground contact of any portion of the vehicle other than the tires will forfeit a run or an entire dynamic event.

The intent is that sliding skirts or other devices that by design, fabrication or as a consequence of moving, contact the track surface are prohibited and any unintended contact with the ground which causes damage, or in the opinion of the Dynamic Event Officials could result in damage to the track, will result in forfeit of a run or an entire dynamic event

V.2 DRIVER

V.2.1 Accommodation

- V.2.1.1 The vehicle must be able to accommodate drivers of sizes ranging from 5th percentile female up to 95th percentile male.

- Accommodation includes driver position, driver controls, and driver equipment.
- Anthropometric data may be found on the FSAE Online Website.

- V.2.1.2 The driver's head and hands must not contact the ground in any rollover attitude.

V.2.2 Visibility

- a. The driver must have sufficient visibility to the front and sides of the vehicle
- b. When seated in a normal driving position, the driver must have a minimum field of vision of 100° to both sides
- c. If mirrors are required for this rule, they must remain in place and adjusted to enable the required visibility throughout all dynamic events.

V.3 SUSPENSION AND STEERING

V.3.1 Suspension

- V.3.1.1 The vehicle must have a fully operational suspension system with shock absorbers, front and rear, with usable minimum wheel travel of 50 mm, with a driver seated.
- V.3.1.2 Officials may disqualify vehicles which do not represent a serious attempt at an operational suspension system, or which demonstrate handling inappropriate for an autocross circuit.
- V.3.1.3 All suspension mounting points must be visible at Technical Inspection by direct view or by removing any covers.
- V.3.1.4 Fasteners in the Suspension system are **Critical Fasteners**, see **T.8.2**
- V.3.1.5 All spherical rod ends and spherical bearings on the suspension and steering must be one of:
 - Mounted in double shear
 - Captured by having a screw/bolt head or washer with an outside diameter that is larger than spherical bearing housing inside diameter.

V.3.2 Steering

- V.3.2.1 The Steering Wheel must be mechanically connected to the front wheels.
- V.3.2.2 Electrically actuated steering of the front wheels is prohibited.

- V.3.2.3 Steering systems must use a rigid mechanical linkage capable of tension and compression loads for operation
- V.3.2.4 The steering system must have positive steering stops that prevent the steering linkages from locking up (the inversion of a four bar linkage at one of the pivots). The stops may be placed on the uprights or on the rack and must prevent the wheels and tires from contacting suspension, bodywork, or Chassis during the track events.
- V.3.2.5 Allowable steering system free play is limited to seven degrees (7°) total measured at the steering wheel.
- V.3.2.6 The steering rack must be mechanically attached to the Chassis
- V.3.2.7 Joints between all components attaching the Steering Wheel to the steering rack must be mechanical and be visible at Technical Inspection. Bonded joints without a mechanical backup are not permitted.
- V.3.2.8 Fasteners in the steering system are **Critical Fasteners**, see **T.8.2**
- V.3.2.9 Spherical rod ends and spherical bearings in the steering must meet **V.3.1.5 above**
- V.3.2.10 Rear wheel steering may be used.
 - a. Rear wheel steering must incorporate mechanical stops to limit the range of angular movement of the rear wheels to a maximum of six degrees (6°).
 - b. The team must provide the ability for the steering angle range to be verified at Technical Inspection with a driver in the vehicle.
 - c. Rear wheel steering may be electrically actuated.

V.3.3 Steering Wheel

- V.3.3.1 In any angular position, the Steering Wheel must meet **T.1.4.2**
- V.3.3.2 The Steering Wheel must be attached to the column with a quick disconnect.
- V.3.3.3 The driver must be able to operate the quick disconnect while in the normal driving position with gloves on.
- V.3.3.4 The Steering Wheel must have a continuous perimeter that is near circular or near oval. The outer perimeter profile may have some straight sections, but no concave sections. “H”, “Figure 8”, or cutout wheels are not allowed.

V.4 WHEELS AND TIRES

V.4.1 Wheel Size

Wheels must be 203.2 mm (8.0 inches) or more in diameter.

V.4.2 Wheel Attachment

- V.4.2.1 Any wheel mounting system that uses a single retaining nut must incorporate a device to retain the nut and the wheel if the nut loosens.
A second nut (jam nut) does not meet this requirement
- V.4.2.2 Teams using modified lug bolts or custom designs must provide proof that Good Engineering Practices have been followed in their design.
- V.4.2.3 If used, aluminum wheel nuts must be hard anodized and in pristine condition.

V.4.3 Tires

Vehicles may have two types of tires, Dry and Wet

V.4.3.1 Dry Tires

- a. The tires on the vehicle when it is presented for Technical Inspection.
- b. May be any size or type, slicks or treaded.

V.4.3.2 Wet Tires

Any size or type of treaded or grooved tire where:

- The tread pattern or grooves were molded in by the tire manufacturer, or were cut by the tire manufacturer or appointed agent.

Any grooves that have been cut must have documented proof that this rule was met

- There is a minimum tread depth of 2.4 mm

V.4.3.3 Tire Set

- a. All four Dry Tires and Wheels or all four Wet Tires and Wheels do not have to be identical.
- b. Once each tire set has been presented for Technical Inspection, any tire compound or size, or wheel type or size must not be changed.

V.4.3.4 Tire Pressure

- a. Tire Pressure must be in the range allowed by the manufacturer at all times.
- b. Tire Pressure may be inspected at any time

V.4.3.5 Requirements for All Tires

- a. Teams must not perform any hand cutting, grooving or modification of the tires.
- b. Tire warmers are not allowed.
- c. No traction enhancers may be applied to the tires at any time onsite at the competition.

F - CHASSIS AND STRUCTURAL

F.1 DEFINITIONS

F.1.1 Chassis

The fabricated structural assembly that supports all functional vehicle systems.

This assembly may be a single fabricated structure, multiple fabricated structures or a combination of composite and welded structures.

F.1.2 Frame Member

A minimum representative single piece of uncut, continuous tubing.

F.1.3 Monocoque

A type of Chassis where loads are supported by the external panels

F.1.4 Main Hoop

A roll bar located alongside or just behind the driver's torso.

F.1.5 Front Hoop

A roll bar located above the driver's legs, in proximity to the steering wheel.

F.1.6 Roll Hoop(s)

Referring to both the Front Hoop AND the Main Hoop

F.1.7 Roll Hoop Bracing Supports

The structure from the lower end of the Roll Hoop Bracing back to the Roll Hoop(s).

F.1.8 Front Bulkhead

A planar structure that provides protection for the driver's feet.

F.1.9 Impact Attenuator

A deformable, energy absorbing device located forward of the Front Bulkhead.

F.1.10 Primary Structure

The combination of the following components:

- Front Bulkhead and Front Bulkhead Support
- Front Hoop, Main Hoop, Roll Hoop Braces and Supports
- Side Impact Structure
- (EV Only) Tractive System Protection and Rear Impact Protection
- Any Frame Members, guides, or supports that transfer load from the Driver Restraint System

F.1.11 Primary Structure Envelope

A volume enclosed by multiple planes, each of which are tangent to the outermost surface of all the Primary Structure Frame Members.

F.1.12 Major Structure

The portion of the Chassis that lies inside the Primary Structure Envelope, excluding the Main Hoop Bracing and the portion of the Main Hoop above a horizontal plane located at the top of the Upper Side Impact Member or top of the Side Impact Zone.

F.1.13 Rollover Protection Envelope

The Primary Structure plus a plane from the top of the Main Hoop to the top of the Front Hoop, plus a plane from the top of the Main Hoop to the rearmost Triangulated structural tube, or monocoque equivalent.

* If there are no Triangulated Structural members aft of the Main Hoop, the Rollover Protection Envelope ends at the rear plane of the Main Hoop

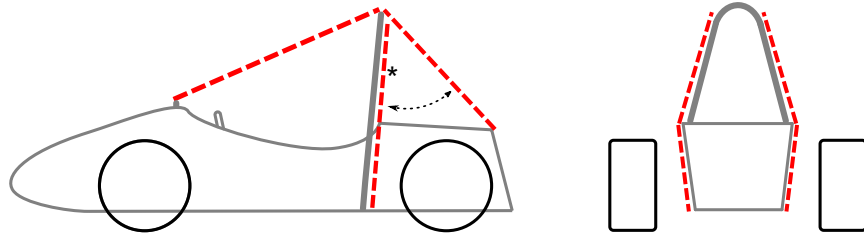

F.1.14 Tire Surface Envelope

The volume enclosed by tangent lines between the Main Hoop and the outside edge of each of the four tires.

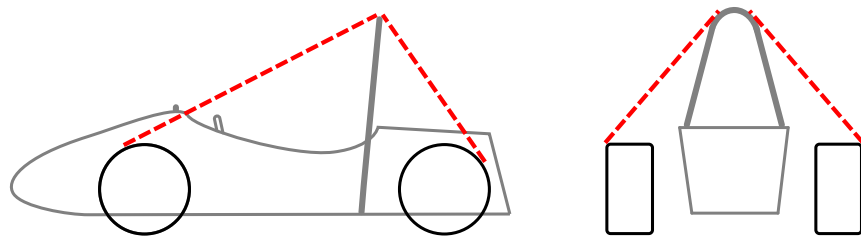

F.1.15 Component Envelope

The area that is inside a plane from the top of the Main Hoop to the top of the Front Bulkhead, plus a plane from the top of the Main Hoop to the rearmost Triangulated structural tube, or monocoque equivalent. * see note in step F.1.13 above

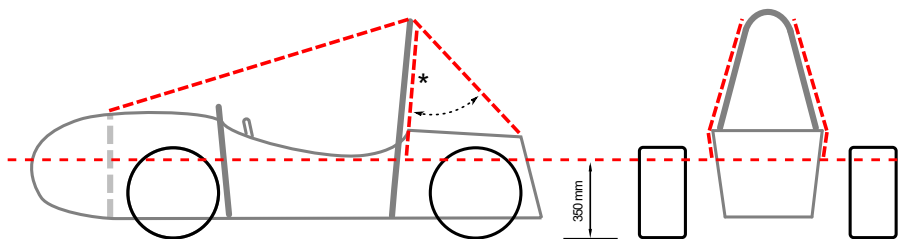

F.1.16 Buckling Modulus (EI)

Equal to $E \cdot I$, where E = modulus of Elasticity, and I = area moment of inertia about the weakest axis.

F.1.17 Triangulation

An arrangement of Frame Members where all members and segments of members between bends or nodes with other structural tubes form a structure composed entirely of triangles.

- a. This is generally required between an upper member and a lower member, both of which may have multiple segments requiring a diagonal to form multiple triangles.
- b. This is also what is meant by “properly triangulated”.

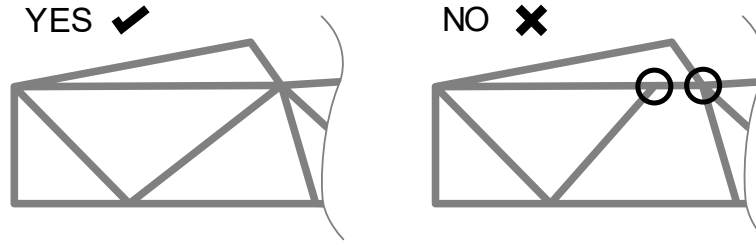

F.1.18 Nonflammable Material

Metal or a Non Metallic material which meets UL94-V0, FAR25 or approved equivalent

F.2 DOCUMENTATION

F.2.1 Structural Equivalency Spreadsheet - SES

F.2.1.1 The SES is a supplement to the Formula SAE Rules and may provide guidance or further details in addition to those of the Formula SAE Rules.

F.2.1.2 The SES provides the means to:

- a. Document the Primary Structure and show compliance with the Formula SAE Rules
- b. Determine Equivalence to Formula SAE Rules using an accepted basis

F.2.2 Structural Documentation

F.2.2.1 All teams must submit a Structural Equivalency Spreadsheet (SES) as given in section **DR - Document Requirements**

F.2.3 Equivalence

F.2.3.1 Equivalency in the structural context is determined and documented with the methods in the SES

F.2.3.2 Any Equivalency calculations must prove Equivalency relative to Steel Tubing in the same application

F.2.3.3 The properties of tubes and laminates may be combined to prove Equivalence.

*For example, in a Side Impact Structure consisting of one tube per **F.3.2.1.e** and a laminate panel, the panel only needs to be Equivalent to two Side Impact Tubes.*

F.2.4 Tolerance

Tolerance on dimensions given in the rules is allowed and is addressed in the SES.

F.2.5 Fabrication

Vehicles must be fabricated in accordance with the design, materials, and processes described in the SES.

F.3 TUBING AND MATERIAL

F.3.1 Dimensions

Diameter and Wall Thickness values provided in this Section F.3 are based on dimensions for commonly available tubing.

F.3.2 Tubing Requirements

F.3.2.1 Requirements by Application

Application	Steel Tube Must Meet Size per F.3.4:	Alternative Tubing Material Permitted per F.3.5 ?
a. Front Bulkhead	Size B	Yes
b. Front Bulkhead Support	Size C	Yes
c. Front Hoop	Size A	Yes
d. Front Hoop Bracing	Size B	Yes
e. Side Impact Structure	Size B	Yes
f. Bent Upper Side Impact Member	Size D	Yes
g. Main Hoop	Size A	NO
h. Main Hoop Bracing	Size B	NO
i. Main Hoop Bracing Supports	Size C	Yes
j. Driver Restraint Harness Attachment	Size B	Yes
k. Shoulder Harness Mounting Bar	Size A	NO
l. Shoulder Harness Mounting Bar Bracing	Size C	Yes
m. Accumulator Protection Structure	Size B	Yes
n. Component Protection	Size C	Yes
o. Other Structural Tubing	Size C	Yes

F.3.3 Non Structural Tubing

F.3.3.1 Definition

Any tubing which does NOT meet **F.3.2.1.o Other Structural Tubing**

F.3.3.2 Applicability

Non Structural Tubing is ignored when assessing compliance to any rule

F.3.4 Steel Tubing and Material

F.3.4.1 Minimum Requirements for Steel Tubing

A tube must meet all four minimum requirements for each Size specified:

Tube	Minimum Area Moment of Inertia	Minimum Cross Sectional Area	Minimum Outside Diameter or Square Width	Minimum Wall Thickness	Example Sizes of Round Tube
a. Size A	11320 mm ⁴	173 mm ²	25.0 mm	2.0 mm	1.0" x 0.095" 25 x 2.5 mm
b. Size B	8509 mm ⁴	114 mm ²	25.0 mm	1.2 mm	1.0" x 0.065" 25.4 x 1.6 mm
c. Size C	6695 mm ⁴	91 mm ²	25.0 mm	1.2 mm	1.0" x 0.049" 25.4 x 1.2 mm
d. Size D	18015 mm ⁴	126 mm ²	35.0 mm	1.2 mm	1.375" x 0.049" 35 x 1.2 mm

F.3.4.2 Properties for ANY steel material for calculations submitted in an SES must be:

a. Non Welded Properties for continuous material calculations:

Young's Modulus (E) = 200 GPa (29,000 ksi)

Yield Strength (Sy) = 305 MPa (44.2 ksi)

Ultimate Strength (Su) = 365 MPa (52.9 ksi)

b. Welded Properties for discontinuous material such as joint calculations:

Yield Strength (Sy) = 180 MPa (26 ksi)

Ultimate Strength (Su) = 300 MPa (43.5 ksi)

F.3.4.3 Where welded tubing reinforcements are required (such as inserts for bolt holes or material to support suspension cutouts), the tubing must retain the Non Welded Properties while using the Welded Properties for the additional reinforcement material.

F.3.5 Alternative Tubing Materials

F.3.5.1 Alternative Materials may be used for applications shown as permitted in **F.3.2.1**

F.3.5.2 If any Alternative Materials are used, the SES must contain:

a. Documentation of material type, (purchase receipt, shipping document or letter of donation) and the material properties.

b. Calculations demonstrating equivalent to or better than the minimum requirements for steel tubing in the application as listed in **F.3.4.1** for yield and ultimate strengths matching the Non Welded Steel properties from **F.3.4.2.a above** in bending, buckling and tension, for buckling modulus and for energy dissipation.

F.3.5.3 Aluminum Tubing

a. Minimum Wall Thickness: Aluminum Tubing 3.0 mm

b. Non Welded properties for aluminum alloy 6061-T6 for calculations in an SES must be:

Young's Modulus (E) = 69 GPa (10,000 ksi)

Yield Strength (Sy) = 240 MPa (34.8 ksi)

Ultimate Strength (Su) = 290 MPa (42.1 ksi)

c. Welded properties for aluminum alloy 6061-T6 for calculations in an SES must be:

Yield Strength (Sy) = 115 MPa (16.7 ksi)

Ultimate Strength (Su) = 175 MPa (25.4 ksi)

d. If welding is used on a regulated aluminum structure, the equivalent yield strength must be considered in the "as welded" condition for the alloy used unless the team provides detailed proof that the frame or component has been properly solution heat treated, artificially aged, and not subject to heating during team manufacturing.

e. If aluminum was solution heat treated and age hardened to increase its strength after welding, the team must supply evidence as to how the process was performed.

This includes, but is not limited to, the heat treating facility used, the process applied, and the fixturing used.

F.3.5.4 Titanium and Magnesium Tubing

a. Minimum Wall Thickness: Titanium Tubing 1.2 mm

b. Minimum Wall Thickness: Magnesium Tubing 3.0 mm

- c. Titanium or magnesium on which any welding has been utilized must not be used for any part of the Primary Structure.

F.4 COMPOSITE AND OTHER MATERIALS

F.4.1 Requirements

If any composite or other material is used, the SES must contain:

- F.4.1.1 Documentation of material type, (purchase receipt, shipping document or letter of donation) and the material properties.
- F.4.1.2 Details of the manufacturing technique and/or composite layup technique as well as the structural material used (examples - cloth type, weight, and resin type, number of layers, core material, and skin material if metal).
- F.4.1.3 Calculations demonstrating equivalence of the structure to one of similar geometry made to meet the minimum requirements for a structure made from steel tubing per **F.3.2**. Equivalency calculations must be submitted for energy dissipation, yield and ultimate strengths in bending, buckling, and tension.
- F.4.1.4 Construction dates of the test panel(s) and monocoque, and approximate age(s) of the materials used.

The intent is for the test panel to use the same material batch, material age, material storage, and student layup quality as the monocoque.

F.4.2 Quasi-Isotropic Layup

A layup with equal fiber strength and stiffness along any orientation in the plane of the layup.

- a. When a layup has equal fiber properties and mass in the 0/90/+45/-45 directions, the layup may be considered Quasi-Isotropic

F.4.3 Laminate Testing

F.4.3.1 Testing Requirements

The same set of test results must not be used for different monocoques in different years.

The intent is for the test panel to use the same material batch, material age, material storage, and student layup quality as the monocoque.

F.4.3.2 Primary Structure Laminate Testing

Teams must build new representative test panels for each ply schedule used in the regulated regions of the new chassis as a flat panel and perform a 3 point bending test on these panels.

- a. Test panels must:
 - Measure one of the two options: 138 mm x 500 mm OR 275 mm x 500 mm
 - Be supported by a span distance of 400 mm
 - Have equal surface area for the top and bottom skin.
 - Have bare edges, without skin material.
- b. The SES must include:
 - Data from the 3 point bending tests
 - Pictures of the test samples

- A picture of the test sample and test setup showing a measurement documenting the supported span distance used in the SES.
- c. Test panel results must be used to derive stiffness, yield strength, ultimate strength and absorbed energy properties by the SES formula for the purpose of calculating laminate panels equivalency corresponding to Primary Structure regions of the chassis.

F.4.3.3 Comparison Test

Teams must make an equivalent test that will determine any compliance in the test rig and establish an absorbed energy value of the baseline tubes.

- a. The comparison test must use two Side Impact steel tubes (F.3.2.1.e)
- b. The steel tubes must be tested to a minimum displacement of 19.0 mm
- c. The calculation of absorbed energy must use the integral of force times displacement from the initiation of load to a displacement of 19.0 mm.

F.4.3.4 Test Conduct

- a. The Laminate test F.4.3.2 and the Comparison test F.4.3.3 must use the same fixture
- b. The load applicator used to test any panel/tubes as required in this section F.4.3 must be:
 - Metallic
 - Radius 50 mm
- c. The load applicator must overhang the test piece to prevent edge loading.
- d. Any other material must not be placed between the load applicator and the items on test.

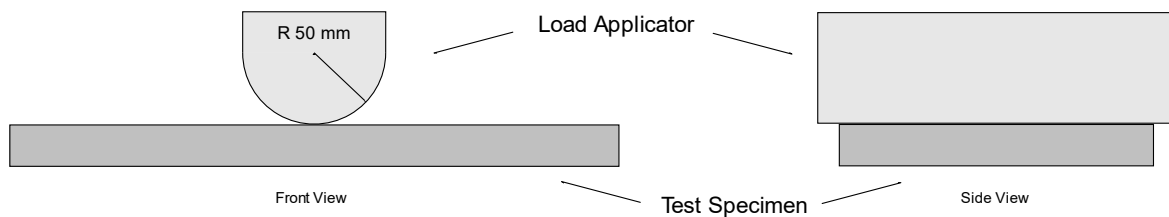

F.4.3.5 Perimeter Shear Test

- a. The Perimeter Shear Test must be completed by measuring the force required to push or pull a 25 mm diameter flat punch through a flat laminate sample.
- b. The sample must:
 - Measure 100 mm x 100 mm minimum
 - Have core and skin thicknesses identical to those used in the actual application
 - Be manufactured using the same materials and processes
- c. The fixture must support the entire sample, except for a 32 mm hole aligned coaxially with the punch.
- d. The sample must not be clamped to the fixture.
- e. The edge of the punch and hole in the fixture may include an optional fillet up to a maximum radius of 1 mm.
- f. The SES must include force and displacement data and photos of the test setup.

- g. The first peak in the load-deflection curve must be used to determine the skin shear strength; this may be less than the minimum force required by **F.7.4.3 / F.7.6.5**
- h. The maximum force recorded must meet the requirements of **F.7.4.3 / F.7.6.5**

F.4.3.6 Additional Testing

When a laminate schedule(s) are NOT a **Quasi-Isotropic Layup (F.4.2)**:

- a. Results from the 3 point bending test will be assigned to the 0 layup direction.
- b. The monocoque must have the tested layup direction normal to the cross sections used for Equivalence in the SES, with allowance for taper of the monocoque normal to the cross section.
- c. All material properties in the weakest direction must be 50% or more of those in the strongest direction as calculated by the SES.

F.4.3.7 Lap Joint Test

The Lap Joint Test measures the force required to pull apart a joint comprised of two laminate samples that are bonded together.

- a. Do two separate tensile tests with different orientations of the adhesive joint:
 - Parallel to the pull direction, with the adhesive joint in pure shear
 - Normal to the pull direction, with the adhesive joint in tension
- b. The samples used must:
 - Have skin thicknesses identical to those used in the actual monocoque
 - Be manufactured using the same materials and processes
 - Have the same overlap as used in the regulated structure. No scaling is permitted.
- c. The force and displacement data and photos of the test setup must be included in the SES.
- d. The shear strength of the bond must be greater than the UTS of the skin.

F.4.4 Buckling Modulus – Equivalent Flat Panel Calculation

- F.4.4.1 When specified, the EI of the chassis must be calculated as the EI of a flat panel with the same composition as the chassis about the neutral axis of the laminate.
- F.4.4.2 The curvature of the panel and geometric cross section of the chassis must be ignored for these calculations.
- F.4.4.3 Calculations of EI that do not reference this section **F.4.4** may take into account the actual geometry of the chassis.

F.5 CHASSIS REQUIREMENTS

This section applies to all Chassis, regardless of material or construction

F.5.1 Primary Structure

- F.5.1.1 The Primary Structure must be constructed from one or a combination of the following:
 - Steel Tubing and Material **F.3.2 F.3.4**
 - Alternative Tubing Materials **F.3.2 F.3.5**
 - Composite Material **F.4**

F.5.1.2 Any chassis design that combines the Tube Frame, Monocoque, tubing and/or composite types must meet all relevant requirements.

For example, a sandwich panel Side Impact Structure in a tube frame chassis

F.5.2 Bent Tubes or Multiple Tubes

F.5.2.1 The minimum radius of any bend, measured at the tube centerline, must be three or more times the tube outside diameter (3 x OD).

F.5.2.2 Bends must be smooth and continuous with no evidence of crimping or wall failure.

F.5.2.3 If a bent tube (or member consisting of multiple tubes that are not in a line) is used anywhere in the Primary Structure other than the Roll Hoops, an additional tube must be attached to support it.

- a. The support tube attachment point must be at the position along the bent tube where it deviates farthest from a straight line connecting both ends
- b. The support tube must terminate at a node of the chassis
- c. The support tube for any bent tube (other than the Upper Side Impact Member or Shoulder Harness Mounting Bar) must be:
 - The same diameter and thickness as the bent tube
 - Angled no more than 30° from the plane of the bent tube

F.5.3 Holes in Tubing

F.5.3.1 Any holes in any regulated tubing (other than inspection holes) must be addressed on the SES.

F.5.3.2 Technical Inspectors may check the compliance of all tubes. This may be done by ultrasonic testing or by the drilling of inspection holes on request.

F.5.4 Fasteners in Primary Structure

F.5.4.1 Bolted connections in the Primary Structure must use a removable bolt and nut.

Bonded fasteners and blind nuts and bolts do not meet this requirement

F.5.4.2 Threaded fasteners used in Primary Structure are **Critical Fasteners**, see **T.8.2**

F.5.4.3 Bolted connections in the Primary Structure using tabs or brackets must have an edge distance ratio "e/D" of 1.5 or greater.

"D" equals the hole diameter. "e" equals the distance from the edge of the hole to the nearest free edge

Tabs attaching the Suspension to the Primary Structure are NOT "in the Primary Structure"

F.5.5 Bonding in Regulated Structure

F.5.5.1 Adhesive used and referenced bonding strength must be appropriate for both substrate types

F.5.5.2 Document the adhesive choice, substrate preparation, and the equivalency of the bonded joint in the SES.

F.5.5.3 The SES will reduce any referenced or tested adhesive values by 50%

F.5.6 Roll Hoops

F.5.6.1 The Chassis must include both a Main Hoop and a Front Hoop.

F.5.6.2 The Main Hoop and Front Hoop must be securely integrated into the Primary Structure using proper Triangulation.

F.5.6.3 Roll Hoop and Driver Position

When seated normally and restrained by the Driver Restraint System, the helmet of a 95th percentile male (see **V.2.1.1**) and all of the team's drivers must:

- Be a minimum of 50 mm from the straight line drawn from the top of the Main Hoop to the top of the Front Hoop.
- Be a minimum of 50 mm from the straight line drawn from the top of the Main Hoop to the lower end of the Main Hoop Bracing if the bracing extends rearwards.
- Be no further rearwards than the rear surface of the Main Hoop if the Main Hoop Bracing extends forwards.

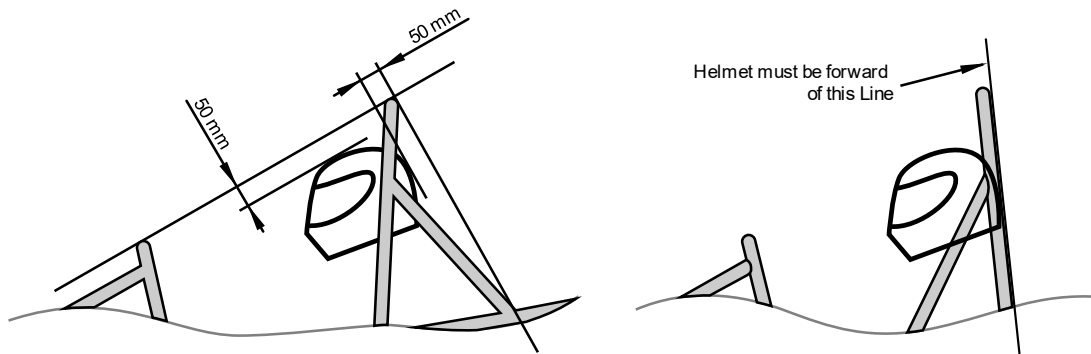

F.5.6.4 Driver Template

A two dimensional template used to represent the 95th percentile male is made to the following dimensions (see figure below):

- A circle of diameter 200 mm will represent the hips and buttocks.
- A circle of diameter 200 mm will represent the shoulder/cervical region.
- A circle of diameter 300 mm will represent the head (with helmet).
- A straight line measuring 490 mm will connect the centers of the two 200 mm circles.
- A straight line measuring 280 mm will connect the centers of the upper 200 mm circle and the 300 mm head circle.

F.5.6.5 Driver Template Position

The Driver Template will be positioned as follows:

- The seat will be adjusted to the rearmost position
- The pedals will be placed in the most forward position
- The bottom 200 mm circle will be placed on the seat bottom where the distance between the center of this circle and the rearmost face of the pedals is no less than 915 mm
- The middle 200 mm circle, representing the shoulders, will be positioned on the seat back
- The upper 300 mm circle will be positioned no more than 25 mm away from the head restraint (where the driver's helmet would normally be located while driving)

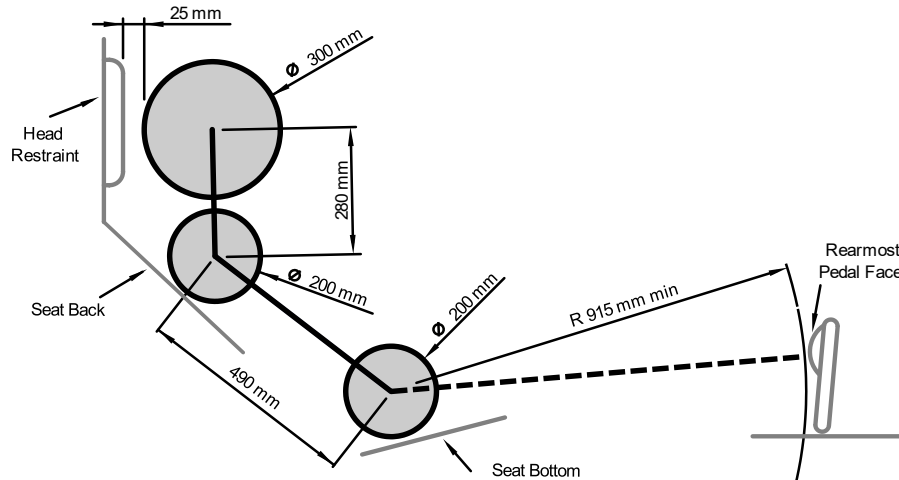

F.5.7 Front Hoop

- F.5.7.1 The Front Hoop must be constructed of closed section metal tubing meeting **F.3.2.1.c**
- F.5.7.2 With proper Triangulation, the Front Hoop may be fabricated from more than one piece of tubing.
- F.5.7.3 The Front Hoop must extend from the lowest Frame Member on one side of the Frame, up, over and down to the lowest Frame Member on the other side of the Frame.
- F.5.7.4 The top-most surface of the Front Hoop must be no lower than the top of the steering wheel in any angular position. See figure following **F.5.9.6 below**
- F.5.7.5 The Front Hoop must be no more than 250 mm forward of the steering wheel.
This distance is measured horizontally, on the vehicle centerline, from the rear surface of the Front Hoop to the forward most surface of the steering wheel rim with the steering in the straight ahead position.
- F.5.7.6 In side view, any part of the Front Hoop above the Upper Side Impact Structure must be inclined less than 20° from the vertical.

F.5.8 Main Hoop

- F.5.8.1 The Main Hoop must be a single piece of uncut, continuous, closed section steel tubing meeting **F.3.2.1.g**
- F.5.8.2 The Main Hoop must extend from the lowest Frame Member / bottom of Monocoque on one side of the Frame, up, over and down to the lowest Frame Member / bottom of Monocoque on the other side of the Frame.
- F.5.8.3 In the side view of the vehicle,
 - a. The part of the Main Hoop that lies above its attachment point to the upper Side Impact Tube must be less than 10° from vertical.
 - b. Any bends in the Main Hoop above its attachment point to the Major Structure of the Chassis must be braced to a node of the Main Hoop Bracing Support structure with tubing meeting **F.3.2.1.h**
 - c. The part of the Main Hoop below the Upper Side Impact Member attachment:
 - May be forward at any angle
 - Must not be rearward more than 10° from vertical

F.5.8.4 In the front view of the vehicle, the vertical members of the Main Hoop must be minimum 380 mm apart (inside dimension) at the location where the Main Hoop is attached to the bottom tubes of the Major Structure of the Chassis.

F.5.9 Main Hoop Braces

F.5.9.1 Main Hoop Braces must be constructed of closed section steel tubing meeting **F.3.2.1.h**

F.5.9.2 The Main Hoop must be supported by two Braces extending in the forward or rearward direction, one on each of the left and right sides of the Main Hoop.

F.5.9.3 In the side view of the Frame, the Main Hoop and the Main Hoop Braces must not lie on the same side of the vertical line through the top of the Main Hoop.

(If the Main Hoop leans forward, the Braces must be forward of the Main Hoop, and if the Main Hoop leans rearward, the Braces must be rearward of the Main Hoop)

F.5.9.4 The Main Hoop Braces must be attached 160 mm or less below the top most surface of the Main Hoop.

The Main Hoop Braces should be attached as near as possible to the top of the Main Hoop

F.5.9.5 The included angle formed by the Main Hoop and the Main Hoop Braces must be 30° or more.

F.5.9.6 The Main Hoop Braces must be straight, without any bends.

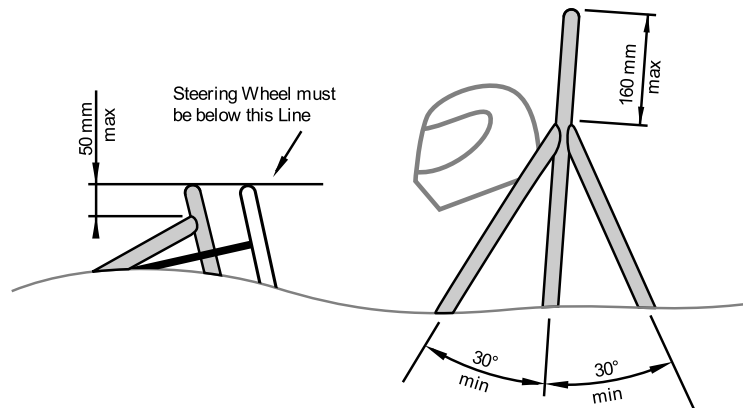

F.5.9.7 The Main Hoop Braces must be:

- Securely integrated into the Frame
- Capable of transmitting all loads from the Main Hoop into the Major Structure of the Chassis without failing

F.5.10 Head Restraint Protection

An additional frame member may be added to meet **T.2.8.3.b**

F.5.10.1 If used, the Head Restraint Protection frame member must:

- Attach to the nodes where the Main Hoop Braces **F.5.9.2** connect to the Main Hoop
- Be constructed of a single piece of uncut, continuous, closed section steel tubing meeting **F.3.2.1.h**
- Meet **F.5.2.1** and **F.5.2.2**, as applicable (does not need to meet **F.5.2.3**)

F.5.10.2 The Head Restraint or mounting **T.2.8** must not attach to the Head Restraint Protection

F.5.11 External Items

F.5.11.1 Any item which meets all three of:

- Located outside the **Component Envelope F.1.15**
- Located above 350 mm from the ground
- Could load the Primary Structure during a rollover

F.5.11.2 External Items must meet one of the two conditions:

- a. Be attached at a Hoop to Brace node or a fully Triangulated structural node without the ability to create a moment at the node
- b. When not attached at a node as described above, then:
 - Additional Structural bracing meeting **F.3.2.1.o** must be added to prevent bending loads
 - Additional calculations must be performed to show the member will not fail in bending or shear, even if unbraced

F.5.11.3 External Items should not point at the driver

F.5.12 Mechanically Attached Roll Hoop Bracing

F.5.12.1 When Roll Hoop Bracing is mechanically attached:

- a. The threaded fasteners used to secure non permanent joints are **Critical Fasteners**, see **T.8.2**. Additional requirements apply in **F.5.12.5** and **F.5.12.7**
- b. No spherical rod ends are allowed.
- c. The attachment holes in the lugs, the attached bracing and the sleeves and tubes must be a close fit with the pin or bolt.

F.5.12.2 Any non permanent joint at the end(s) must be a Double Lug Joint or a Sleeved Butt Joint

Figure – Double Lug Joint

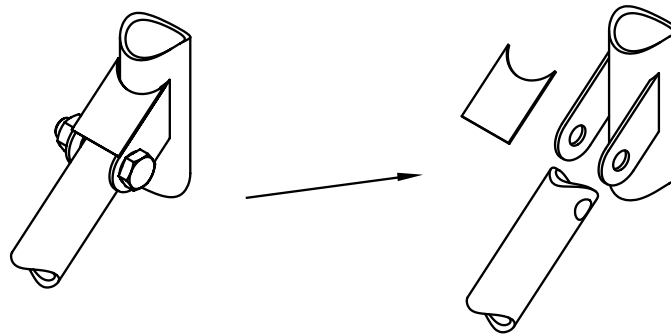

F.5.12.3 For Double Lug Joints, each lug must:

- a. Be minimum 4.5 mm (0.177 in) thickness steel
- b. Measure 25 mm minimum perpendicular to the axis of the bracing
- c. Be as short as practical along the axis of the bracing.

F.5.12.4 All Double Lug Joints, whether fitted parallel or perpendicular to the axis of the tube, must include a capping arrangement

- F.5.12.5 In a Double Lug Joint the pin or bolt must be **10 mm Metric Grade 9.8 or 3/8 in SAE Grade 8** minimum diameter and grade. See **F.5.12.1 above**

Figure – Sleeved Butt Joint

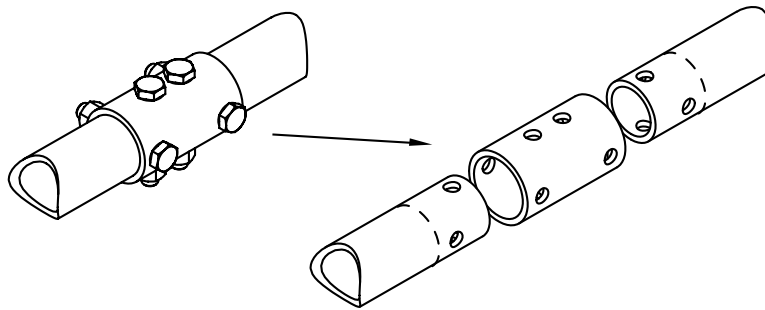

- F.5.12.6 For Sleeved Butt Joints, the sleeve must:
- Have a minimum length of 75 mm; 37.5 mm to each side of the joint
 - Be external to the base tubes, with a close fit around the base tubes.
 - Have a wall thickness equal to or greater than 2.0 mm
- F.5.12.7 In a Sleeved Butt Joint, the bolts must be **6 mm Metric Grade 9.8 or 1/4 in SAE Grade 8** minimum diameter and grade. See **F.5.12.1 above**

F.5.13 Other Bracing Requirements

- F.5.13.1 Where the braces are not welded to steel Frame Members, the braces must be securely attached to the Frame using 8 mm or 5/16" minimum diameter **Critical Fasteners**, see **T.8.2**
- F.5.13.2 Mounting plates welded to Roll Hoop Bracing must be 2.0 mm (0.080 in) minimum thickness steel.

F.5.14 Other Side Tube Requirements

If there is a Roll Hoop Brace or other frame tube alongside the driver, at the height of the neck of any of the team's drivers, a metal tube or piece of sheet metal must be firmly attached to the Frame

This is intended to prevent the drivers' shoulders from passing under the Roll Hoop Brace or frame tube, and the driver's neck contacting this brace or tube.

F.5.15 Component Protection

When designated, components must be protected by one or both of:

- Fully Triangulated structure with tubes meeting **F.3.2.1.n**
- Structure Equivalent to the above, as determined per **F.4.1.3**

F.6 TUBE FRAMES

F.6.1 Front Bulkhead

The Front Bulkhead must be constructed of closed section tubing meeting **F.3.2.1.a**

F.6.2 Front Bulkhead Support

- F.6.2.1 Frame Members of the Front Bulkhead Support system must be constructed of closed section tubing meeting **F.3.2.1.b**
- F.6.2.2 The Front Bulkhead must be securely integrated into the Frame.

- F.6.2.3 The Front Bulkhead must be supported back to the Front Hoop by a minimum of three Frame Members on each side of the vehicle; an upper member; lower member and diagonal brace to provide Triangulation.
- The upper support member must be attached 50 mm or less from the top surface of the Front Bulkhead, and attach to the Front Hoop inside a zone extending 100 mm above and 50 mm below the Upper Side Impact member.
 - If the upper support member is further than 100 mm above the Upper Side Impact member, then properly Triangulated bracing is required to transfer load to the Main Hoop by one of:
 - the Upper Side Impact member
 - an additional member transmitting load from the junction of the Upper Support Member with the Front Hoop
 - The lower support member must be attached to the base of the Front Bulkhead and the base of the Front Hoop.
 - The diagonal brace must properly Triangulate the upper and lower support members
- F.6.2.4 Each of the above members may be multiple or bent tubes provided the requirements of **F.5.2** are met.
- F.6.2.5 Examples of acceptable configurations of members may be found in the SES

F.6.3 Front Hoop Bracing

- F.6.3.1 Front Hoop Braces must be constructed of material meeting **F.3.2.1.d**
- F.6.3.2 The Front Hoop must be supported by two Braces extending in the forward direction, one on each of the left and right sides of the Front Hoop.
- F.6.3.3 The Front Hoop Braces must be constructed to protect the driver's legs and should extend to the structure in front of the driver's feet.
- F.6.3.4 The Front Hoop Braces must be attached as near as possible to the top of the Front Hoop but not more than 50 mm below the top-most surface of the Front Hoop. See figure following **F.5.9.6 above**
- F.6.3.5 If the Front Hoop above the Upper Side Impact Structure leans rearwards by more than 10° from the vertical, it must be supported by additional rearward Front Hoop Braces to a fully Triangulated structural node.
- F.6.3.6 The Front Hoop Braces must be straight, without any bends

F.6.4 Side Impact Structure

- F.6.4.1 Frame Members of the Side Impact Structure must be constructed of closed section tubing meeting **F.3.2.1.e** or **F.3.2.1.f** for a Bent Upper Side Impact member
- F.6.4.2 With proper Triangulation, Side Impact Structure members may be fabricated from more than one piece of tubing.
- F.6.4.3 The Side Impact Structure must be comprised of three or more tubular members located on each side of the driver while seated in the normal driving position

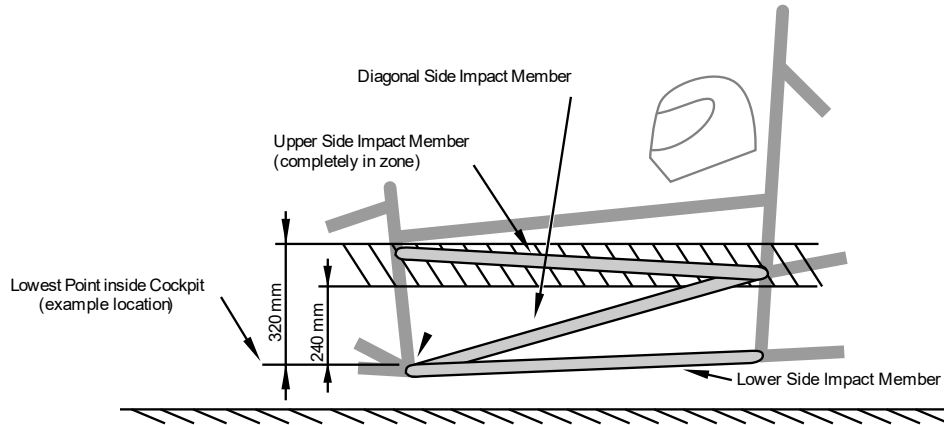

F.6.4.4 The Upper Side Impact Member must:

- a. Connect the Main Hoop and the Front Hoop.
- b. Be entirely in a zone that is parallel to the ground between 240 mm and 320 mm above the lowest point of the top surface of the Lower Side Impact Member

The upper frame rail may be used as this member if it meets the height, diameter and thickness requirements.

F.6.4.5 The Lower Side Impact Structure member must connect the bottom of the Main Hoop and the bottom of the Front Hoop.

The lower frame rail/frame member may be this member if it meets the diameter and wall thickness requirements.

F.6.4.6 The Diagonal Side Impact Member must:

- a. Connect the Upper Side Impact Member and Lower Side Impact Member forward of the Main Hoop and rearward of the Front Hoop
- b. Completely Triangulate the bays created by the Upper and Lower Side Impact Members.

F.6.5 Shoulder Harness Mounting

F.6.5.1 The Shoulder Harness Mounting Bar must:

- a. Be a single piece of uncut, continuous, closed section steel tubing that meets **F.3.2.1.k**
- b. Attach to the Main Hoop on both sides of the chassis

F.6.5.2 Bent Shoulder Harness Mounting Bars must:

- a. Meet **F.5.2.1** and **F.5.2.2**
- b. Have bracing members attached at the bend(s) and to the Main Hoop.
 - Material for this Shoulder Harness Mounting Bar Bracing must meet **F.3.2.1.l**
 - The included angle in side view between the Shoulder Harness Bar and the braces must be no less than 30°.

F.6.6 Main Hoop Bracing Supports

F.6.6.1 Frame Members of the Main Hoop Bracing Support system must be constructed of closed section tubing meeting **F.3.2.1.i**

- F.6.6.2 The lower end of the Main Hoop Braces must be supported back to the Main Hoop by a minimum of two Frame Members on each side of the vehicle: an upper member and a lower member in a properly Triangulated configuration.
- The upper support member must attach to the node where the upper Side Impact Member attaches to the Main Hoop.
 - The lower support member must attach to the node where the lower Side Impact Member attaches to the Main Hoop.
 - Each of the above members may be multiple or bent tubes provided the requirements of **F.5.2** are met.
 - Examples of acceptable configurations of members may be found in the SES.

F.7 MONOCOQUE

F.7.1 General Requirements

- F.7.1.1 The Structural Equivalency Spreadsheet must demonstrate that the design is equivalent to a welded frame in terms of energy dissipation, yield and ultimate strengths in bending, buckling and tension.
- F.7.1.2 Composite and metallic monocoques have the same requirements.

F.7.2 Composite Monocoques

- F.7.2.1 Composite monocoques must meet the materials requirements in **F.4 Composite and Other Materials**
- F.7.2.2 Data from the laminate testing results must be used as the basis for any strength or stiffness calculations.

F.7.3 Front Bulkhead

- F.7.3.1 When modeled as an “L” shaped section the EI of the Front Bulkhead about both vertical and lateral axis must be equivalent to that of the tubes specified for the Front Bulkhead per **F.6.1**
- F.7.3.2 The length of the section perpendicular to the Front Bulkhead may be a maximum of 25 mm measured from the rearmost face of the Front Bulkhead.
- F.7.3.3 Any Front Bulkhead which supports the IA plate must have a perimeter shear strength equivalent to a 1.5 mm thick steel plate.

F.7.4 Front Bulkhead Support

- F.7.4.1 In addition to proving that the strength of the monocoque is sufficient, the monocoque must have equivalent EI to the sum of the EI of the six Steel Tubes (**F.3.2.1.b**) that it replaces.
- F.7.4.2 The EI of the vertical side of the Front Bulkhead support structure must be equivalent to or greater than the EI of one steel tube that it replaces when calculated as per **F.4.4**
- F.7.4.3 The perimeter shear strength of the monocoque laminate in the Front Bulkhead support structure must be 4 kN or more for a section with a diameter of 25 mm.
This must be proven by a physical test completed per **F.4.3.5** and the results included in the SES.

F.7.5 Front Hoop Attachment

- F.7.5.1 The Front Hoop must be mechanically attached to the monocoque
- F.7.5.2 Front Hoop attachment to a monocoque must obey **F.5.7.2** or **F.7.9** within 25 mm of any bends and nodes that are not at the top center of the Front Hoop

- F.7.5.3 The Front Hoop may be fully laminated into the monocoque
- Fully laminating means encapsulating the Front Hoop with an appropriate number and arrangement of plies.
 - Equivalence to six or more mounts compliant with **F.7.9** must be shown in the SES.

F.7.5.4 Adhesive must not be the sole method of attaching the Front Hoop to the monocoque.

F.7.6 Side Impact Structure

F.7.6.1 **Side Impact Zone** - the region longitudinally forward of the Main Hoop and aft of the Front Hoop consisting of the combination of a vertical section up to 320 mm above the lowest point of the upper surface of the floor to the bottom surface of the floor of the monocoque and half the horizontal floor.

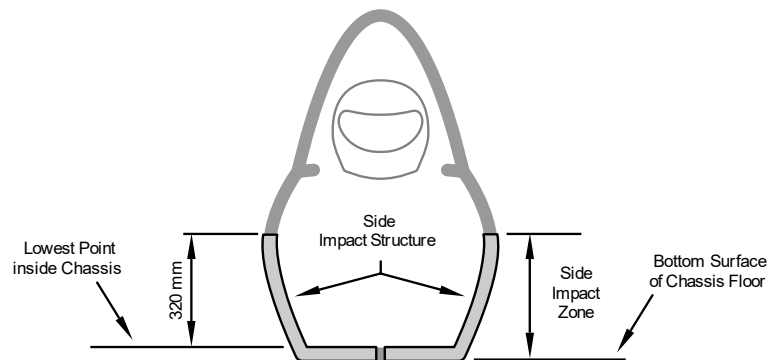

F.7.6.2 The Side Impact Zone must have a Buckling Modulus (EI) equal to three (3) Steel Tubes (**F.3.2.1.e**) that it replaces.

F.7.6.3 The portion of the Side Impact Zone that is vertically between the upper surface of the floor and 320 mm above the lowest point of the upper surface of the floor (see figure above) must have:

- Buckling Modulus (EI) equivalent to minimum two (2) Steel Tubes (**F.3.2.1.e**) per **F.4.4**
- Absorbed energy equivalent to minimum two (2) Steel Tubes (**F.3.2.1.e**).

Proof of equivalent absorbed energy is determined by physical testing per **F.4.3.1** and **F.4.3.3**

F.7.6.4 Horizontal floor Equivalence must be calculated per **F.4.4**

F.7.6.5 The perimeter shear strength of the monocoque laminate must be 7.5 kN or more for a section with a diameter of 25 mm.

This must be proven by physical test completed per **F.4.3.5** and the results included in the SES.

F.7.7 Main Hoop Attachment

F.7.7.1 The Main Hoop must be mechanically attached to the monocoque

F.7.7.2 Main Hoop attachment to a monocoque must obey **F.7.9** within 25 mm of any bends and nodes that are below the top of the monocoque

F.7.7.3 Mounting plates welded to the Roll Hoop must be 2.0 mm minimum thickness steel.

F.7.8 Roll Hoop Bracing Attachment

Attachment of tubular Front or Main Hoop Bracing to the monocoque must obey **F.7.9**.

F.7.9 Attachments

- F.7.9.1 Each attachment point between the monocoque and the other Primary Structure must be able to carry a minimum load of 30 kN in any direction.
- When a Roll Hoop attaches in three locations on each side, the attachments must be located at the bottom, top, and a location near the midpoint
 - When a Roll Hoop attaches at only the bottom and a point between the top and the midpoint on each side, each of the four attachments must show load strength of 45 kN in all directions
- F.7.9.2 The laminate, brackets, backing plates and inserts must have sufficient stiffness, shear area, bearing area, weld area and strength to carry the load specified in **F.7.9.1** in any direction. Data obtained from the laminate perimeter shear strength test (**F.4.3.5**) must be used to prove sufficient shear area is provided.
- F.7.9.3 Proof that the brackets are sufficiently stiff must be documented in the SES.
- F.7.9.4 Each attachment point requires no less than two 8 mm or 5/16" minimum diameter **Critical Fasteners**, see **T.8.2**
- F.7.9.5 Each attachment point requires backing plates which meet one of:
- Steel with a minimum thickness of 2 mm
 - Alternate materials, if Equivalency is approved
- F.7.9.6 The Front Hoop Bracing, Main Hoop Bracing and Main Hoop Bracing Supports may use only one 10 mm or 3/8" minimum diameter **Critical Fasteners**, see **T.8.2** as an alternative to **F.7.9.4 above** if the bolt is on the centerline of the bracing tube to prevent loading the bolt in bending, similar to the figure below.

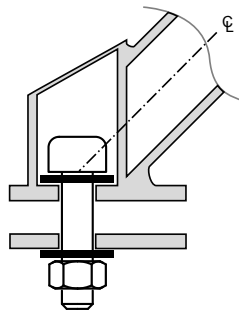

- F.7.9.7 No crushing of the core is permitted

F.7.10 Driver Harness Attachment

- F.7.10.1 Required Loads
- Each attachment point for the Shoulder Belts must support a minimum load of 15 kN before failure with a required load of 30 kN distributed across both belt attachments.
 - Each attachment point for the Lap Belts must support a minimum load of 15 kN before failure.
 - Each attachment point for the Anti-Submarine Belts must support a minimum load of 15 kN before failure.
 - If the Lap Belt and Anti-Submarine Belt mounting points are less than 125 mm apart, or are attached to the same attachment point, then each mounting point must support a minimum load of 30 kN before failure.

F.7.10.2 Load Testing

The strength of Lap Belt, Shoulder Belt, and Anti-Submarine Belt attachments must be proven by physical tests where the required load is applied to a representative attachment point where the proposed layup and attachment bracket are used.

- a. Edges of the test fixture supporting the sample must be a minimum of 125 mm from the load application point (load vector intersecting a plane).
- b. Test load application must be normal to the plane of the test sample
- c. The Shoulder Harness test sample must not be any larger than the section of the monocoque as built.
- d. The width of the Shoulder Harness test sample must not be any wider than the Shoulder Harness "panel height" (see Structural Equivalency Spreadsheet) used to show equivalency for the Shoulder Harness mounting bar.
- e. Designs with attachments near a free edge must not support the free edge during the test.

The intent is that the test specimen, to the best extent possible, represents the vehicle as driven at competition. Teams are expected to test a panel that is manufactured in as close a configuration to what is built in the vehicle as possible

F.8 FRONT CHASSIS PROTECTION

F.8.1 Requirements

- F.8.1.1 Forward of the Front Bulkhead there must be an Impact Attenuator with an Anti Intrusion Plate between the Impact Attenuator and the Front Bulkhead.
- F.8.1.2 All methods of attachment of the Impact Attenuator to the Anti Intrusion Plate, and of the Anti Intrusion Plate to the Front Bulkhead must provide sufficient load paths for transverse and vertical loads if off-axis impacts occur.

F.8.2 Anti Intrusion Plate - AIP

- F.8.2.1 The Anti Intrusion Plate must be one of the following:
 - a. 1.5 mm minimum thickness solid steel
 - b. 4.0 mm minimum thickness solid aluminum plate
 - c. Composite material per **F.8.3**
- F.8.2.2 The outside profile requirement of the Anti Intrusion Plate depends on the method of attachment to the Front Bulkhead:
 - a. Welded joints: the profile must extend to, or past the centerline of the Front Bulkhead tubes on all sides.
 - b. Bolted joints: the profile must match the outside dimensions of the Front Bulkhead around the entire periphery.
- F.8.2.3 Attachment of the Anti Intrusion Plate directly to the Front Bulkhead must be documented in the team's SES submission. The accepted methods of attachment are:
 - a. Welding
 - Welds may be continuous or interrupted
 - If interrupted, the weld/space ratio must be 1:1 or greater
 - All weld lengths must be greater than 25 mm

- b. Bolted joints
 - Using no less than eight 8 mm or 5/16" minimum diameter **Critical Fasteners, T.8.2.**
 - The distance between any two bolt centers must be 50 mm minimum.
 - Each bolt attachment must have pullout, tearout and bending capabilities of 15 kN
- F.8.2.4 All Non Crushable Items inside the Primary Structure must have a minimum 25 mm clearance to the rear face of the Anti Intrusion Plate.
- Non Crushable Items include, but are not limited to batteries, master cylinders, hydraulic reservoirs*
- F.8.3 Composite Anti Intrusion Plate**
- F.8.3.1 Composite Anti Intrusion Plates:
- a. Must not fail in a frontal impact
 - b. Must withstand a minimum static load of 120 kN distributed over the 200 mm x 100 mm minimum Impact Attenuator area
- F.8.3.2 Strength of the Composite Anti Intrusion Plate must be verified by one of the two methods:
- a. Physical testing of the AIP attached to a structurally representative section of the intended chassis
 - The test fixture must have equivalent strength and stiffness to a baseline front bulkhead or must be the same as the first 50 mm of the Chassis
 - Test data is valid for only one Competition Year
 - b. Laminate material testing under **F.4.3.1** and **F.4.3.5** and calculations of 3 point bending and perimeter shear
- F.8.4 Impact Attenuator - IA**
- F.8.4.1 Teams must do one of:
- Use an approved Standard Impact Attenuator from the FSAE Online Website
 - Build and test a Custom Impact Attenuator of their own design
- F.8.4.2 The Custom Impact Attenuator must meet the following:
- a. Length 200 mm or more, with its length oriented along the fore/aft axis of the Chassis.
 - b. Minimum height 100 mm (perpendicular to the ground) and minimum width 200 mm (parallel to the ground) for a minimum distance of 200 mm forward of the Front Bulkhead.
 - c. Segmented foam attenuators must have all segments bonded together to prevent sliding or parallelogramming.
 - d. Honeycomb attenuators made of multiple segments must have a continuous panel between each segment.
- F.8.4.3 If the outside profile of the Front Bulkhead is greater than 400 mm x 350 mm, or the team uses the Standard Honeycomb Impact Attenuator, and then one of the following must be met:
- a. The Front Bulkhead must include a diagonal or X-brace that is a Front Bulkhead Support tube meeting **F.3.2.1.b**, or Equivalent for Monocoque bulkheads
 - b. Physical testing must be performed to prove that the Anti Intrusion Plate does not permanently deflect more than 25 mm.

F.8.5 Impact Attenuator Attachment

F.8.5.1 The attachment of the Impact Attenuator to the Anti Intrusion Plate or Front Bulkhead must be documented in the SES submission

F.8.5.2 Standard Impact Attenuators must be attached by bonding

F.8.5.3 Custom Impact Attenuators must be attached by bonding, welding, or bolting

F.8.5.4 When the Impact Attenuator is attached by bonding:

- a. Bonding must meet **F.5.5**
- b. The shear strength of the bond must be greater than:
 - 95 kN for foam Impact Attenuators
 - 38.5 kN for honeycomb Impact Attenuators
 - The maximum compressive force for custom Impact Attenuators
- c. The entire surface of a foam Impact Attenuator must be bonded
- d. Only the pre-crushed area of a honeycomb Impact Attenuator may be used for bond equivalence

F.8.5.5 When the Impact Attenuator is attached by welding:

- a. Welds may be continuous or interrupted
- b. If interrupted, the weld/space ratio must be 1:1 or greater
- c. All weld lengths must be greater than 25 mm

F.8.5.6 When the Impact Attenuator is attached by bolting:

- a. Must have no less than four 8 mm or 5/16" minimum diameter **Critical Fasteners, T.8.2**
- b. The distance between any two bolt centers must be 50 mm minimum
- c. Each bolt attachment must have pullout, tearout and bending capabilities of 15 kN

F.8.5.7 Position - the top leading edge of the Impact Attenuator must be between 240mm and 320mm from the lowest point on the top of the Lower Side Impact Structure

F.8.6 Non Crushable Objects

F.8.6.1 The combination of the Impact Attenuator assembly and the force to crush or detach all other items forward of the Anti Intrusion plate must not exceed the peak deceleration specified in **F.8.7.2**

Ignore light bodywork, light nosecones, and outboard wheel assemblies

F.8.6.2 The peak load for the type of Impact Attenuator:

- | | |
|--|------------------|
| • Standard Foam Impact Attenuator | 95 kN |
| • Standard Honeycomb Impact Attenuator | 60 kN |
| • Tested Impact Attenuator | peak as measured |

F.8.6.3 Use the Test Method or the Calculation Method to prove the force requirement

F.8.6.4 Test Method

Get the peak force from physical testing of the Impact Attenuator and any Non Crushable Object(s) as one of the two:

- a. Tested together with the Impact Attenuator
- b. Tested with the Impact Attenuator not attached, and add the peak load from **F.8.6.2**

F.8.6.5 Calculation Method

- a. Calculate a failure load for the mounting of the Non Crushable Object(s) from fastener shear, tearout, and/or link buckling
- b. Add the peak attenuator load from **F.8.6.2**

F.8.6.6 The front wing and front wing mounts must be able to move completely behind the Anti Intrusion Plate and not touch the chassis in the event of a frontal impact

F.8.7 Impact Attenuator Data - IAD

F.8.7.1 All teams must include an Impact Attenuator Data (IAD) report as part of the SES.

F.8.7.2 Impact Attenuator Functional Requirements

These are not test requirements

- a. Decelerates the vehicle at a rate not exceeding 20 g average and 40 g peak
- b. Energy absorbed must be more than 7350 J

When:

- Total mass of Vehicle is 300 kg
- Impact velocity is 7.0 m/s

F.8.7.3 When using the Standard Impact Attenuator, the SES must meet the following:

- a. Test data will not be submitted
- b. All other requirements of this section must be included.
- c. Photos of the actual attenuator must be included
- d. Evidence that the Standard IA meets the design criteria provided in the Standard Impact Attenuator specification must be included with the SES. This may be a receipt or packing slip from the supplier.

F.8.7.4 The Impact Attenuator Data Report when NOT using the Standard Impact Attenuator must include:

- a. Test data that proves that the Impact Attenuator Assembly meets the Functional Requirements **F.8.7.2**
- b. Calculations showing how the reported absorbed energy and decelerations have been derived.
- c. A schematic of the test method.
- d. Photos of the attenuator, annotated with the height of the attenuator before and after testing.

F.8.7.5 The Impact Attenuator Test is valid for only one Competition Year

F.8.7.6 Impact Attenuator Test Setup

- a. During any test, the Impact Attenuator must be attached to the Anti Intrusion Plate using the intended vehicle attachment method.
- b. The Impact Attenuator Assembly must be attached to a structurally representative section of the intended chassis.

The test fixture must have equivalent strength and stiffness to a baseline front bulkhead. A solid block of material in the shape of the front bulkhead is not “structurally representative”.

- c. There must be 50 mm minimum clearance rearwards of the Anti Intrusion Plate to the test fixture.
- d. No part of the Anti Intrusion Plate may permanently deflect more than 25 mm beyond the position of the Anti Intrusion Plate before the test.

The 25 mm spacing represents the front bulkhead support and insures that the plate does not intrude excessively into the cockpit.

F.8.7.7 Test Conduct

- a. Composite Impact Attenuators must be Dynamic Tested.
Other Impact Attenuator constructions may be Dynamic Tested or Quasi-Static Tested
- b. Dynamic Testing (sled, pendulum, drop tower, etc.) of the Impact Attenuator must be conducted at a dedicated test facility. This facility may be part of the University, but must be supervised by professional staff or the University faculty. Teams must not construct their own dynamic test apparatus.
- c. Quasi-Static Testing may be performed by teams using their University's facilities/equipment, but teams are advised to exercise due care when performing all tests.

F.8.7.8 Test Analysis

- a. When using acceleration data from the dynamic test, the average deceleration must be calculated based on the raw unfiltered data.
- b. If peaks above the 40 g limit are present in the data, a Channel Filter Class (CFC) 60 (100Hz) filter per SAE Recommended Practice J211 "Instrumentation for Impact Test", or a 100 Hz, 3rd order, low pass Butterworth (-3dB at 100 Hz) filter may be applied.

F.9 FUEL SYSTEM (IC ONLY)

Fuel System Location and Protection are subject to approval during SES review and Technical Inspection.

F.9.1 Location

- F.9.1.1 Any portion of the Fuel System that is less than 350 mm above the ground, and all parts of the Fuel Tank, must be inside the Primary Structure (**F.1.10**).
- F.9.1.2 In side view, any portion of the Fuel System must not project below the lower surface of the chassis

F.9.2 Protection

All Fuel Tanks must be shielded from side or rear impact collisions.

F.10 ACCUMULATOR CONTAINER (EV ONLY)

F.10.1 General Requirements

- F.10.1.1 All Accumulator Containers must be:
 - a. Designed to withstand forces from deceleration in all directions
 - b. Made from a Nonflammable Material (**F.1.18**)
- F.10.1.2 Design of the Accumulator Container must be documented in the SES.
Documentation includes materials used, drawings/images, fastener locations, cell/segment weight and cell/segment position.

F.10.1.3 The Accumulator Containers and mounting systems are subject to approval during SES review and Technical Inspection.

F.10.2 External Structure

F.10.2.1 The Floor or Bottom must be made from one of the three:

- a. Steel 1.25 mm minimum thickness
- b. Aluminum 3.2 mm minimum thickness
- c. Equivalent Alternate / Composite materials (**F.4.1, F.4.3**)

F.10.2.2 Vertical Walls, Covers and Lids must be made from one of the three:

- a. Steel 0.9 mm minimum thickness
- b. Aluminum 2.3 mm minimum thickness
- c. Equivalent Alternate / Composite materials (**F.4.1, F.4.3**)

F.10.2.3 The accepted methods of joining walls to walls and walls to floor are:

- a. Welding
 - Welds may be continuous or interrupted.
 - If interrupted, the weld/space ratio must be 1:1 or greater
 - All weld lengths must be greater than 25 mm
- b. Fasteners

Combined strength of the fasteners must be Equivalent to the strength of the welded joint (**F.10.2.3.a above**)
- c. Bonding
 - Bonding must meet **F.5.5**
 - Strength of the bonded joint must be Equivalent to the strength of the welded joint (**F.10.2.3.a above**)
 - Bonds must run the entire length of the joint

F.10.2.4 Covers and Lids must be attached with a minimum of one fastener for each external vertical wall per section.

F.10.3 Internal Structure

F.10.3.1 Walls

- a. Construction of Internal walls (vertical or horizontal) separating cells and/or segments must meet **F.10.2.2**
- b. Internal vertical walls separating cells and/or segments must have minimum height of the full height of the Accumulator Segments
- c. Fastened connections between the floor and any vertical wall of each Section must have minimum of two fasteners.
- d. Removable horizontal interior walls must be fastened with a minimum of one fastener for each external vertical wall per section.

Folding or bending plate material to create flanges or to eliminate joints between walls is recommended.

F.10.3.2 Sections

- a. Internal vertical walls divide the Accumulator Container into “Sections”
- b. A maximum of 12 kg is allowed in any Section
- c. Fastened connections between vertical walls around Sections containing 8kg or less must have a minimum of two fasteners
- d. Fastened connections between vertical walls around sections containing between 8 kg and 12 kg must have a minimum of three fasteners

Example: An Accumulator Container with 2 internal walls has 3 Sections. Each Section contains less than 8 kg. Therefore 18 floor to wall joints are required in total with minimum two fasteners per joint.

F.10.3.3 If segments are arranged vertically above other segments, each layer of segments must have a load path to the Chassis attachments that does not pass through another layer of segments

F.10.3.4 Cells and Segments

- a. The cells and/or segments must be appropriately secured against moving inside the Container.
- b. This mounting system design must withstand the following accelerations:
 - 40 g in the longitudinal direction (forward/aft)
 - 40 g in the lateral direction (left/right)
 - 20 g in the vertical direction (up/down)
- c. Calculations and/or tests proving these requirements are met must be included in the SES.
- d. Any fasteners must be 6 mm or 1/4” minimum diameter

F.10.4 Holes and Openings

F.10.4.1 The Accumulator Container(s) exterior or interior walls may contain holes or openings, see [EV.5.3.4](#)

F.10.4.2 Any Holes and Openings must be the minimum size necessary

F.10.4.3 Exterior and interior walls must cover a minimum of 75% of each face of the battery segments

F.10.4.4 Holes and Openings for airflow:

- a. Must be round. Slots are prohibited
- b. Should be maximum 10 mm diameter
- c. Must not have line of sight to the driver, with the Firewall installed or removed

F.10.5 Attachment

F.10.5.1 Accumulator Containers must be attached to the Major Structure of the chassis

F.10.5.2 Attachment of the Accumulator Container must be documented in the SES

F.10.5.3 Any fasteners used to attach Accumulator Container(s) are **Critical Fasteners**, see [T.8.2](#)

F.10.5.4 Each attachment point to a composite Accumulator Container requires steel backing plates with a thickness of 2 mm minimum.

Alternate materials may be used for backing plates when proven Equivalent

F.10.5.5 Teams may justify the Accumulator Container attachment using one of:

- Corner Attachments and Analysis per **F.10.5.6**
- Load Based Analysis per **F.10.5.7**

F.10.5.6 Accumulator Attachment – Corner Attachments

- a. Eight or more attachments are required for any configuration.
 - One attachment for each corner of a rectangular structure of multiple Accumulator Segments
 - More than the minimum number of fasteners may be required for non rectangular arrangements

Examples: If not filled in with additional structure, an extruded L shape would require attachments at 10 convex corners (the corners at the inside of the L are not convex); an extruded hexagon would require 12 attachments
- b. The mechanical connections at each corner must be:
 - 50 mm or less from the corner of the Segment
 - Spaced minimum 50 mm from the mechanical connection of any other corner
 - The same fastener diameter and grade
- c. Each attachment point must be able to withstand a Test Load.
 - The Test Load is equal to 1/4 of total mass of the container accelerating at 40 g
 - Every fastener must withstand the Test Load in pure shear, using the minor diameter if any threads are in shear.
 - Every Accumulator bracket, chassis bracket, or monocoque attachment point must withstand the Test Load in bending, in pure tearout, pure pullout, pure weld shear if welded, and pure bond shear and pure bond tensile if bonded.

F.10.5.7 Accumulator Attachment – Load Based

- a. The minimum number of attachment points depends on the total mass of the container:

Accumulator Weight	Minimum Attachment Points
< 20 kg	4
20 – 30 kg	6
30 – 40 kg	8
> 40 kg	10

- b. Any brackets which attach the Accumulator Container to the chassis must:
 - Be made of steel 1.6 mm minimum thickness or aluminum 4 mm minimum thickness
 - Have gussets to carry bending loads.
- c. Each attachment point, including any brackets, backing plates and inserts, must be able to withstand 15 kN in any direction
- d. Fasteners must spaced minimum 50 mm apart to be counted as separate attachment points.
- e. A maximum of two attachment points may be on a chassis tube between two triangulated nodes.

F.11 TRACTIVE SYSTEM (EV ONLY)

Tractive System Location and Protection are subject to approval during SES review and Technical Inspection.

F.11.1 Location

F.11.1.1 All Accumulator Containers must lie inside the Primary Structure (**F.1.10**).

F.11.1.2 When used, Outboard Wheel Motors and their connections must meet **EV.5.1.3**

F.11.1.3 Tractive System (**EV.1.1**) components including cables and wiring other than those in **F.11.1.2 above** must be contained inside one or both of:

- The Rollover Protection Envelope **F.1.13**
- Structure meeting **F.5.15 Component Protection**

F.11.2 Protection

F.11.2.1 Side Impact Protection

a. All Accumulator Containers must be protected from side impact by structure Equivalent to Side Impact Structure (**F.6.4, F.7.6**)

The Accumulator Container must not form part of the Equivalent structure.

b. Other Tractive System components in a position below 350 mm from the ground must be protected from side impact by structure meeting **F.5.15 Component Protection**

F.11.2.2 Rear Impact Protection

a. All Accumulator Containers must be protected from rear impact:

- When the rear impact structure is 100 mm or less from an Accumulator Container, the structure must be Side Impact Structure (**F.6.4, F.7.6**, or Equivalent)
- When the rear impact structure is more than 100 mm from an Accumulator Container, the structure must meet **F.5.15 Component Protection**
- The Accumulator Container must not form part of the Equivalent structure.

b. The Rear Impact Protection for the Accumulator Container must:

- Go to the Upper Side Impact Height at minimum
- Be supported to the Side Impact Structure

c. Other Tractive System components in a position below 350 mm from the ground must be protected from rear impact by structure meeting **F.5.15 Component Protection**

d. Differential mounts or a plate behind upper and lower rear impact tubes may be used as Rear Impact Protection.

If used, the mounts or plate must be 25 mm or more larger at both the top and bottom of the upper and lower tubes

F.11.2.3 All Non Crushable Items should have a minimum 25 mm clearance to the surface of the Accumulator Container.

Non Crushable Items include, but are not limited to motors, differentials, and the side or rear impact structure itself. Accumulator mounts do not require clearance

F.11.2.4 Non Crushable Items mounted behind the Rear Impact structure must not be able to come through the Rear Impact structure.

T - TECHNICAL ASPECTS

T.1 COCKPIT

T.1.1 Cockpit Opening

T.1.1.1 The template shown below must pass through the cockpit opening

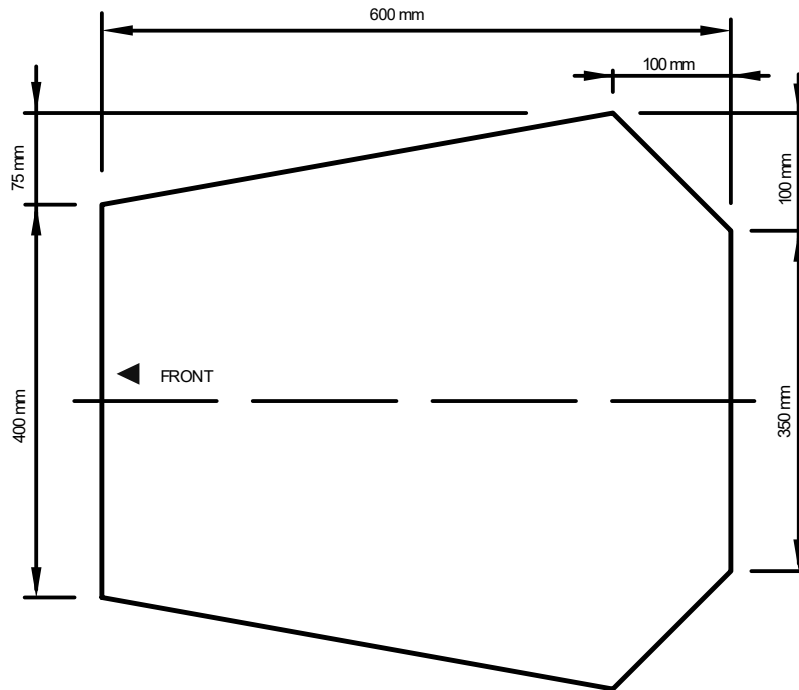

T.1.1.2 The template will be held horizontally, parallel to the ground, and inserted vertically from a height above any Primary Structure or bodywork that is between the Front Hoop and the Main Hoop until it meets both of: (refer to **F.6.4** and **F.7.6.1**)

- Has passed 25 mm below the lowest point of the top of the Side Impact Structure
- Is less than or equal to 320 mm above the lowest point inside the cockpit

T.1.1.3 Fore and aft translation of the template is permitted during insertion.

T.1.1.4 During this test:

- The steering wheel, steering column, seat and all padding may be removed.
- The shifter or shift mechanism may not be removed unless it is integral with the steering wheel and is removed with the steering wheel.
- The firewall must not be moved or removed.
- Cables, wires, hoses, tubes, etc. must not impede the template

During inspection, the steering column, for practical purposes, will not be removed. The template may be maneuvered around the steering column, but not any fixed supports.

For ease of use, the template may contain a slot at the front center that the steering column may pass through.

T.1.2 Internal Cross Section

T.1.2.1 Requirement:

- a. The cockpit must have a free internal cross section
- b. The template shown below must pass through the cockpit

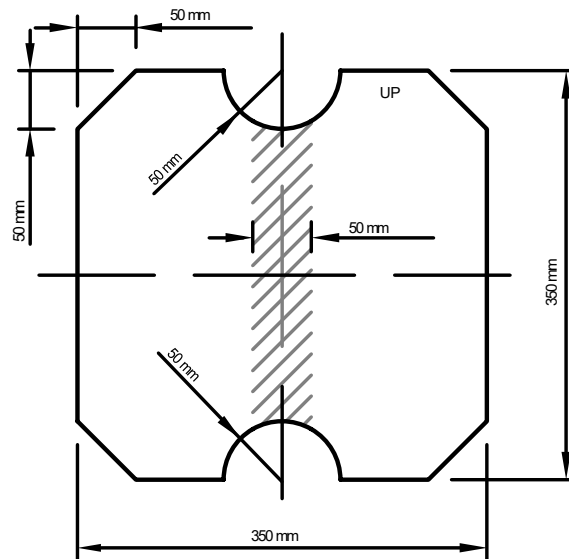

Template maximum thickness: 7 mm

T.1.2.2 Conduct of the test. The template:

- a. Will be held vertically and inserted into the cockpit opening rearward of the rearmost portion of the steering column.
- b. Will then be passed horizontally through the cockpit to a point 100 mm rearwards of the face of the rearmost pedal when in the inoperative position
- c. May be moved vertically inside the cockpit

T.1.2.3 During this test:

- a. If the pedals are adjustable, they must be in their most forward position.
- b. The steering wheel may be removed
- c. Padding may be removed if it can be easily removed without the use of tools with the driver in the seat
- d. The seat and any seat insert(s) that may be used must remain in the cockpit
- e. Cables, wires, hoses, tubes, etc. must not impede the template
- f. The steering column and associated components may pass through the 50 mm wide center band of the template.

For ease of use, the template may contain a full or partial slot in the shaded area shown on the figure

T.1.3 Driver Protection

T.1.3.1 The driver's feet and legs must be completely contained inside the Major Structure of the Chassis.

T.1.3.2 While the driver's feet are touching the pedals, in side and front views, any part of the driver's feet or legs must not extend above or outside of the Major Structure of the Chassis.

T.1.3.3 All moving suspension and steering components and other sharp edges inside the cockpit between the Front Hoop and a vertical plane 100 mm rearward of the pedals must be covered by a shield made of a solid material.

Moving components include, but are not limited to springs, shock absorbers, rocker arms, anti-roll/sway bars, steering racks and steering column CV joints.

T.1.3.4 Covers over suspension and steering components must be removable to allow inspection of the mounting points.

T.1.4 Controls Accessibility

T.1.4.1 All vehicle controls must be operated from inside the cockpit without any part of the driver, including hands, arms or elbows, being outside of:

- a. The Side Impact Structure defined in **F.6.4 / F.7.6**
- b. Two longitudinal vertical planes parallel to the centerline of the chassis touching the uppermost member of the Side Impact Structure

T.1.4.2 All vehicle controls must stay below the top-most surface of the Front Hoop in any operational position

T.1.5 Driver's Seat

T.1.5.1 The Driver's Seat must be protected by one of the following:

- a. In side view, the lowest point of any Driver's Seat must be no lower than the upper surface of the lower frame rails
- b. A longitudinal tube (or tubes) that meets the requirements for Side Impact tubing (**F.3.2.1.e**), passing underneath the lowest point of the Driver Seat.

T.1.6 Thermal Protection

T.1.6.1 When seated in the normal driving position, sufficient heat insulation must be provided to ensure that the driver will not contact any metal or other materials which may become heated to a surface temperature above 60°C.

T.1.6.2 Insulation may be external to the cockpit or incorporated with the Driver's Seat or Firewall.

T.1.6.3 The design must address all three types of heat transfer between the heat source (exhaust pipe, coolant hose/tube) and the panel that the driver could contact (seat or floor):

- a. Conduction Isolation by one of the following:
 - No direct contact between the heat source and the panel
 - A heat resistant, conduction isolation material with a minimum thickness of 8 mm between the heat source and the panel.
- b. Convection Isolation by a minimum air gap of 25 mm between the heat source and the panel
- c. Radiation Isolation by one of the following:
 - A solid metal heat shield with a minimum thickness of 0.4 mm
 - Reflective foil or tape when combined with conduction insulation.

T.1.7 Floor Closeout

- T.1.7.1 All vehicles must have a Floor Closeout to prevent track debris from entering
- T.1.7.2 The Floor Closeout must extend from the foot area to the firewall
- T.1.7.3 The panel(s) must be made of a solid, non brittle material.
- T.1.7.4 If multiple panels are used, gaps between panels must not exceed 3 mm.

T.1.8 Firewall(s)

T.1.8.1 Requirement

A Firewall(s) must separate the driver compartment and any portion of the Driver Harness from:

- a. All components of the fuel supply, the engine oil, the liquid cooling systems, any lithium batteries
- b. (EV only) All Tractive System components that are not subject to **T.1.9.4**

T.1.8.2 Construction

Any Firewall must:

- a. Be a non permeable surface made from a rigid, Nonflammable Material
- b. Seal completely against the passage of fluids (the Firewall itself, edges, and Floor Closeout)
- c. Be rigidly mounted

T.1.8.3 Positioning

The Firewall must extend sufficiently far upwards and/or rearwards and/or sideways where any point on the drivers body less than 100 mm above the bottom of the helmet of the tallest driver must not be in direct line of sight with any part mentioned in **T.1.8.1 above**

T.1.8.4 Details

- a. Firewalls composed of multiple panels must overlap and be sealed at the joints
Sealing between firewalls cannot be a stressed part of the Firewall
- b. Grommets must be used to seal any pass through for wiring, cables, etc
- c. Any seals or adhesives used with the Firewall must be rated for the application environment

T.1.8.5 (EV only) The Accumulator Container may be used as part of the Firewall if it meets these requirements

T.1.9 Tractive System Firewalls (EV Only)

T.1.9.1 Tractive System Firewalls must meet the requirements of **T.1.8 above**

T.1.9.2 Tractive System Firewalls must be composed of two layers: (see **IN.8.1**)

- a. The layer facing the Tractive System must be:
 - Made of aluminum with a thickness between 0.5 and 0.7 mm
 - Grounded according to **EV.7.7 Grounding**
- b. The layer facing the Driver must be:
 - Made of an electrically insulating and Nonflammable Material (**F.1.18**), not CFRP

- Sufficient thickness to prevent penetrating this layer with a 4 mm wide screwdriver and 250 N of force.

This is a check that may be performed at Tech Inspection, not a design criteria

T.1.9.3 Conductive parts other than the Chassis must meet one of:

- Not protrude through the Firewall
- Be properly insulated on the driver side

T.1.9.4 When Outboard Wheel Motors **EV.5.1.3** are mounted at the wheels, the line of sight requirement of **T.1.8.3 above** does not apply to components at the wheels or on the front control arms.

T.2 DRIVER ACCOMMODATION

T.2.1 Harness Definitions

- a. 5 Point Harness – consists of two Lap Belts, two Shoulder Belts and one Anti-Submarine Belt.
- b. 6 Point Harness – consists of two Lap Belts, two Shoulder Belts and two leg or Anti-Submarine Belts.
- c. 7 Point Harness – consists of two Lap Belts, two Shoulder Belts, two leg or Anti-Submarine Belts and a negative g or Z Belt.
- d. Upright Driving Position - with a seat back angled at 30° or less from the vertical as measured along the line joining the two 200 mm circles of the template of the 95th percentile male as defined in **F.5.6.4** and positioned per **F.5.6.5**
- e. Reclined Driving Position - with a seat back angled at more than 30° from the vertical as measured along the line joining the two 200 mm circles of the template of the 95th percentile male as defined in **F.5.6.4** and positioned per **F.5.6.5**
- f. Chest to Groin Line - the straight line that in side view follows the line of the Shoulder Belts from the chest to the release buckle.

T.2.2 Harness Specification

T.2.2.1 The vehicle must use a 5, 6 or 7 Point Harness meeting one or more of the following:

- a. [SFI Specification 16.1](#)
- b. [SFI Specification 16.5](#)
- c. [FIA specification 8853/98](#)
- d. [FIA specification 8853/2016](#)

T.2.2.2 The belts must have the original manufacturers labels showing the specification and expiration date

T.2.2.3 The Harness must be in or before the year of expiration shown on the labels. Harnesses expiring on or before Dec 31 of the calendar year of the competition are permitted.

T.2.2.4 The Harness must be in new or like new condition, with no signs of wear, cuts, chaffing or other issues.

T.2.2.5 All Harness hardware must be threaded in accordance with manufacturer's instructions.

T.2.2.6 All Harness hardware must be used as received from the manufacturer. No modification (including drilling, cutting, grinding, etc) is permitted.

T.2.3 Harness Requirements

T.2.3.1 Vehicles with a Reclined Driving Position must have:

- a. A 6 Point Harness or a 7 Point Harness
- b. Anti-Submarine Belts with tilt lock adjusters (“quick adjusters”) OR two sets of Anti-Submarine Belts installed.

T.2.3.2 All Lap Belts must incorporate a tilt lock adjuster (“quick adjuster”).

Lap Belts with “pull-up” adjusters are recommended over “pull-down” adjusters.

T.2.3.3 The Shoulder Belts must be the over the shoulder type. Only separate shoulder straps are permitted. “Y” type shoulder straps are not allowed. The “H” type configuration is allowed.

T.2.4 Belt, Strap and Harness Installation - General

T.2.4.1 The Lap Belt, Shoulder Belts and Anti-Submarine Belt(s) must be securely mounted to the Primary Structure.

T.2.4.2 Any guide or support for the belts must be material meeting **F.3.2.1.j**

T.2.4.3 Each tab or bracket to which any part of the Harness is attached must:

- a. Have a minimum cross sectional area of 60 mm² of steel to be sheared or failed in tension at any point of the tab
- b. Be 1.6 mm minimum thickness
- c. Not be in bending when the attached part of the Harness is put under load.
- d. Where Lap Belts and Anti-Submarine Belts use the same attachment point, there must be a minimum cross sectional area of 90 mm² of steel to be sheared or failed in tension at any point of the tab.
- e. Not cause abrasion to the belt webbing

T.2.4.4 Attachment of tabs or brackets must meet the following:

- a. Where brackets are fastened to the chassis, no less than two 6 mm or 1/4” minimum diameter **Critical Fasteners**, see **T.8.2** or stronger must be used to attach the bracket to the chassis.
- b. Where a single shear tab is welded to the chassis, the tab to tube welding must be on both sides of the base of the tab.

Double shear attachments are preferred. Tabs and brackets for double shear mounts should be welded on both sides.

T.2.4.5 Harness installation must meet **T.1.8.1**

T.2.5 Lap Belt Mounting

T.2.5.1 The Lap Belts must pass around the pelvic area below the Anterior Superior Iliac Spines (the hip bones).

T.2.5.2 Installation of the Lap Belts must go in a straight line from the mounting point until they reach the driver’s body without touching any hole in the seat or any other intermediate structure

T.2.5.3 The seat must be rolled or grommeted where the Belts or Harness pass through a hole in the seat

T.2.5.4 In side view, the Lap Belt must be capable of pivoting freely by using a shouldered bolt or an eye bolt attachment.

T.2.5.5 Lap Belts must not be mounted by wrapping them around frame tubes.

T.2.5.6 With an Upright Driving Position:

- a. The Lap Belt Side View Angle must be between 45° and 65° to the horizontal.
- b. The centerline of the Lap Belt at the seat bottom should be between 0 – 75 mm forward of the seat back to seat bottom junction.

T.2.5.7 With a Reclined Driving Position, the Lap Belt Side View Angle must be between 60° and 80° to the horizontal.

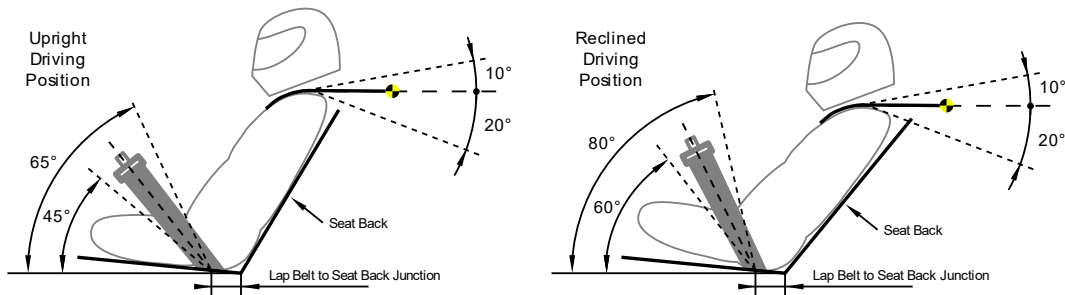

T.2.5.8 Any bolt used to attach a Lap Belt, directly to the chassis or to an intermediate bracket, is a **Critical Fasteners**, see **T.8.2**, with a minimum diameter that is the smaller of:

- The bolt diameter specified by the manufacturer
- 10 mm or 3/8"

T.2.6 Shoulder Harness

T.2.6.1 From the driver's shoulders rearwards to the mounting point or structural guide, the Shoulder Belt Side View Angle must be between 10° above the horizontal and 20° below the horizontal.

T.2.6.2 The Shoulder Belt Mount Spacing must be between 175 mm and 235 mm, center to center

T.2.6.3 Any bolt used to attach a Shoulder Belt, directly to the chassis or to an intermediate bracket, is a **Critical Fasteners**, see **T.8.2**, with a minimum diameter that is the smaller of:

- The bolt diameter specified by the manufacturer
- 10 mm or 3/8"

T.2.7 Anti-Submarine Belt Mounting

T.2.7.1 The Anti-Submarine Belt of a 5 point harness must be mounted with the mounting point in line with or slightly forward of the driver's Chest to Groin Line with an Anti-Submarine Belt Side View Angle no more than 20°

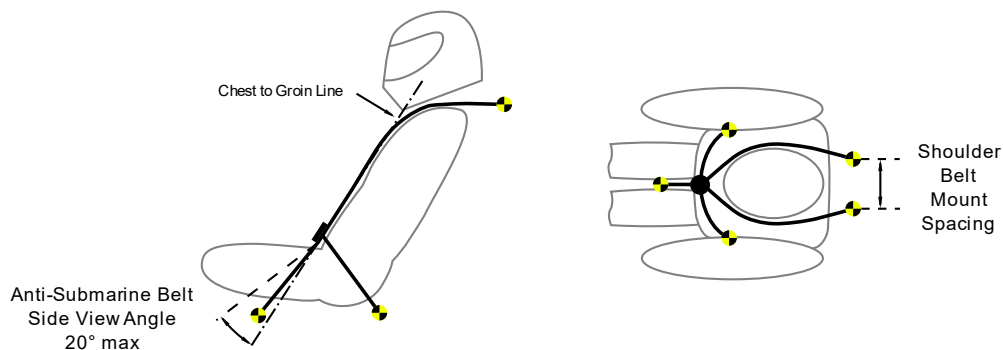

- T.2.7.2 The Anti-Submarine Belts of a 6 point harness must be mounted in one of the following ways:
- With the belts going vertically down from the groin, or with an Anti-Submarine Belt Side View Angle up to 20° rearwards. The Anti-Submarine Belt Mount Spacing should be approximately 100 mm apart.

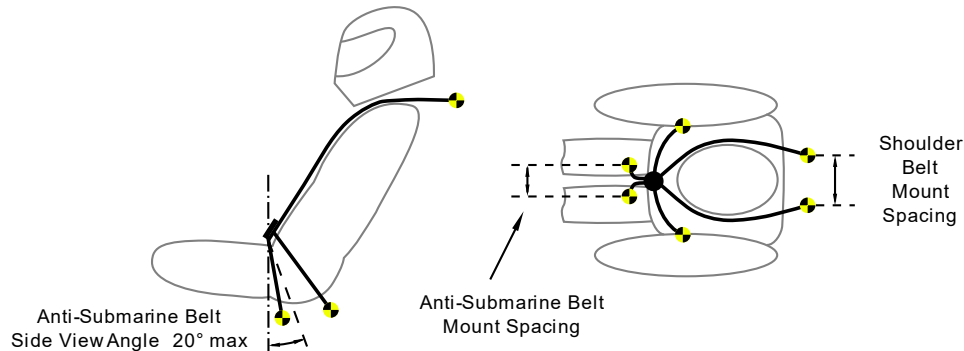

- With the Anti-Submarine Belt Mounting Points on the Primary Structure at or near the Lap Belt anchorages, the driver sitting on the Anti-Submarine Belts, and the belts coming up around the groin to the release buckle.

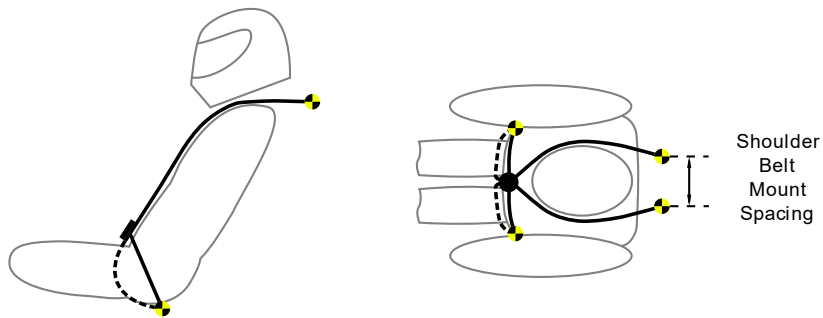

- T.2.7.3 Installation of all Anti-Submarine Belts must go in a straight line from the Anti-Submarine Belt Mounting Point(s) without touching any hole in the seat or any other intermediate structure until they reach:

- The release buckle for the 5 Point Harness mounting per **T.2.7.1**
- The first point where the belt touches the driver's body for the 6 Point Harness mounting per **T.2.7.2**

- T.2.7.4 Any bolt used to attach an Anti-Submarine Belt, directly to the chassis or to an intermediate bracket, is a **Critical Fasteners**, see **T.8.2**, with a minimum diameter that is the smaller of:

- The bolt diameter specified by the manufacturer
- 8 mm or 5/16"

T.2.8 Head Restraint

T.2.8.1 A Head Restraint must be provided to limit the rearward motion of the driver's head.

T.2.8.2 The Head Restraint must be vertical or near vertical in side view.

T.2.8.3 All material and structure of the Head Restraint must be inside one or both of:

- Rollover Protection Envelope **F.1.13**
- Head Restraint Protection (if used) **F.5.10**

- T.2.8.4 The Head Restraint, attachment and mounting must be strong enough to withstand a minimum force of:
- 900 N applied in a rearward direction
 - 300 N applied in a lateral or vertical direction
- T.2.8.5 For all drivers, the Head Restraint must be located and adjusted where:
- The Head Restraint is no more than 25 mm away from the back of the driver's helmet, with the driver in their normal driving position.
 - The contact point of the back of the driver's helmet on the Head Restraint is no less than 50 mm from any edge of the Head Restraint.
- Approximately 100 mm of longitudinal adjustment should accommodate range of specified drivers. Several Head Restraints with different thicknesses may be used*
- T.2.8.6 The Head Restraint padding must:
- Be an energy absorbing material that is one of the two:
 - Meets [SFI Spec 45.2](#)
 - CONFOR CF45 (Blue) or CONFOR CF45M (Blue) (FIA Technical List No 17)
 - Have a minimum thickness of 38 mm
 - Have a minimum width of 15 cm
 - Meet one of the following:
 - minimum area of 235 cm² AND minimum total height adjustment of 17.5 cm
 - minimum height of 28 cm
 - Be covered with a thin, flexible material that contains a ~20 mm diameter inspection hole in a surface other than the front surface

T.2.9 Roll Bar Padding

Any portion of the roll bar, roll bar bracing or Chassis which might be contacted by the driver's helmet must be covered with a minimum thickness of 12 mm of padding which meets [SFI Spec 45.1](#) or [FIA 8857-2001](#).

T.3 BRAKE SYSTEM

T.3.1 Mechanical

- T.3.1.1 The vehicle must have a braking system
- T.3.1.2 The braking system must:
- Act on all four wheels
 - Be operated by a single control
 - Be capable of locking all four wheels
- T.3.1.3 The braking system must have two independent hydraulic circuits.
A leak or failure at any point in the system will maintain effective braking power on minimum two wheels.
- T.3.1.4 Each hydraulic circuit must have its own fluid reserve using separate reservoirs or an OEM style reservoir
- T.3.1.5 A single brake acting on a limited slip differential may be used.

- T.3.1.6 “Brake by Wire” systems are prohibited.
- T.3.1.7 Unarmored plastic brake lines are prohibited.
- T.3.1.8 The braking systems must be protected with scatter shields from failure of the drive train (see **T.5.2**) or from minor collisions.
- T.3.1.9 In side view any portion of the brake system that is mounted on the sprung part of the vehicle must not project below the lower surface of the chassis
- T.3.1.10 Fasteners in the Brake system are **Critical Fasteners**, see **T.8.2**
- T.3.1.11 The brake pedal must be one of:
 - Fabricated from steel or aluminum
 - Machined from steel, aluminum or titanium
- T.3.1.12 The brake pedal and associated system components design must withstand a minimum force of 2000 N without any failure of the brake system or pedal box.
This is not a design criteria. The brake system may be tested by pressing the pedal with the maximum force that can be exerted by any official when seated normally.
- T.3.1.13 Failure of non-loadbearing components in the braking system must not interfere with brake pedal operation or brake system function
- T.3.1.14 (EV only) Additional requirements for Electric Vehicles:
 - a. The first 90% of the brake pedal travel may be used to regenerate brake energy without actuating the hydraulic brake system.
 - b. The remaining brake pedal travel must directly actuate the hydraulic brake system. Brake energy regeneration may remain active.

T.3.2 Brake Over Travel Switch - BOTS

- T.3.2.1 The vehicle must have a Brake Over Travel Switch (BOTS). Brake pedal travel exceeding the normal range will actuate the switch
- T.3.2.2 The BOTS must be a mechanical single pole, single throw (commonly known as a two position) switch (push-pull or flip type).
- T.3.2.3 Operation of the BOTS to the OFF position must Open the Shutdown Circuit **IC.9.2.2 / EV.8.2.2**
- T.3.2.4 Repeated operation of the switch must not reset or restore power
- T.3.2.5 The driver must not be able to reset the BOTS.
- T.3.2.6 The switch must be implemented with analog components, and not using programmable logic controllers, engine control units, or similar functioning digital controllers.

T.3.3 Brake Light

- T.3.3.1 The vehicle must have a Brake Light that is clearly visible from the rear in very bright sunlight.
- T.3.3.2 The Brake Light must be:
 - a. Red in color on a Black background
 - b. Rectangular, triangular or near round shape with a minimum shining surface of 15 cm²
 - c. Mounted between the wheel centerline and driver’s shoulder level vertically and approximately on vehicle centerline laterally.
- T.3.3.3 When LED lights are used without a diffuser, they must not be more than 20 mm apart.
- T.3.3.4 If a single line of LEDs is used, the minimum length is 150 mm.

T.4 ELECTRONIC THROTTLE COMPONENTS

T.4.1 Applicability

This section T.4 applies only for:

- IC vehicles using Electronic Throttle Control (ETC) **IC.4**
- EV vehicles

T.4.2 Accelerator Pedal Position Sensor - APPS

T.4.2.1 The APPS must be actuated by a foot pedal.

- a. Pedal travel is defined as percent of travel from a fully released position to a fully applied position where 0% is fully released and 100% is fully applied.
- b. The foot pedal must return to its original position when not actuated.
- c. The foot pedal must have a positive stop preventing the mounted sensors from being damaged or overstressed.
- d. Two springs must be used to return the foot pedal to the off position
- e. Each spring must be capable of returning the pedal to the fully released position with the other disconnected. The springs in the APPS are not acceptable pedal return springs.

T.4.2.2 Two or more electrically separate sensors must be used as APPSs. A single OEM type APPS with two completely separate sensors in a single housing is acceptable.

T.4.2.3 The APPS sensors must have different transfer functions which meet one of:

- Each sensor has a positive slope sense with different gradients and/or offsets to the other(s).
- An OEM pedal sensor with opposite slopes. Non OEM opposite slope sensor configurations require prior approval.

The intent is that in a short circuit the APPSs will only agree at 0% pedal position.

T.4.2.4 Implausibility is defined as a deviation of more than 10% pedal travel between the sensors or other failure as defined in this Section T.4.2. Use of values larger than 10% require justification in the FMEA and may not be approved

T.4.2.5 If an implausibility occurs between the values of the APPSs and persists for more than 100 msec, the power to the (IC) electronic throttle / (EV) Motor(s) must be immediately stopped completely.

(EV only) It is not necessary to Open the Shutdown Circuit, the motor controller(s) stopping the power to the Motor(s) is sufficient.

T.4.2.6 If three sensors are used, then in the case of an APPS failure, any two sensors that agree within 10% pedal travel may be used to define the (IC) throttle position / (EV) torque target and the 3rd APPS may be ignored.

T.4.2.7 Each APPS must be able to be checked during Technical Inspection by having one of:

- A separate detachable connector that enables a check of functions by unplugging it
- An inline switchable breakout box available that allows disconnection of each APPS signal.

T.4.2.8 The APPS signals must be sent directly to a controller using an analogue signal or via a digital data transmission bus such as CAN or FlexRay.

- T.4.2.9 Any failure of the APPS or APPS wiring must be detectable by the controller and must be treated like an implausibility, see **T.4.2.4 above**
- T.4.2.10 When an analogue signal is used, the APPS will be considered to have failed when they achieve an open circuit or short circuit condition which generates a signal outside of the normal operating range, for example $<0.5\text{ V}$ or $>4.5\text{ V}$.
- The circuitry used to evaluate the sensor must use pull down or pull up resistors to ensure that open circuit signals result in a failure being detected.
- T.4.2.11 When any kind of digital data transmission is used to transmit the APPS signal,
- The FMEA study must contain a detailed description of all the potential failure modes that can occur, the strategy that is used to detect these failures and the tests that have been conducted to prove that the detection strategy works.
 - The failures to be considered must include but are not limited to the failure of the APPS, APPS signals being out of range, corruption of the message and loss of messages and the associated time outs.
- T.4.2.12 The current rules are written to only apply to the APPS (pedal), but the integrity of the torque command signal is important in all stages.
- T.4.3 Brake System Encoder - BSE**
- T.4.3.1 A Brake System Encoder or switch to measure brake pedal position or brake system pressure must be fitted to check for plausibility
- T.4.3.2 The BSE must be able to be checked during Technical Inspection by having one of:
- A separate detachable connector(s) for any BSE signal(s) to the main ECU without affecting any other connections
 - An inline switchable breakout box available that allows disconnection of each BSE signal(s) to the main ECU without affecting any other connections.
- T.4.3.3 The BSE or switch signals must be sent directly to a controller using an analogue signal or via a digital data transmission bus such as CAN or FlexRay.
- Any failure of the BSE or BSE wiring that persists more than 100 msec must be detectable by the controller and treated like an implausibility and power to the (IC) electronic throttle / (EV) Motor(s) must be immediately stopped completely.
- (EV only) It is not necessary to completely deactivate the Tractive System, the motor controller(s) stopping power to the motor(s) is sufficient.
- T.4.3.4 When an analogue signal is used, the BSE sensors will be considered to have failed when they achieve an open circuit or short circuit condition which generates a signal outside of the normal operating range, for example $<0.5\text{ V}$ or $>4.5\text{ V}$.
- The circuitry used to evaluate the sensor must use pull down or pull up resistors to ensure that open circuit signals result in a failure being detected.
- T.4.3.5 When any kind of digital data transmission is used to transmit the BSE signal:
- The FMEA study must contain a detailed description of all the potential failure modes that can occur, the strategy that is used to detect these failures and the tests that have been conducted to prove that the detection strategy works.
 - The failures modes must include but are not limited to the failure of the sensor, sensor signals being out of range, corruption of the message and loss of messages and the associated time outs.

- c. In all cases a sensor failure must immediately shutdown power to the motor(s).

T.5 POWERTRAIN

T.5.1 Transmission and Drive

Any transmission and drivetrain may be used.

T.5.2 Drivetrain Shields and Guards

T.5.2.1 Exposed high speed final drivetrain equipment such as Continuously Variable Transmissions (CVTs), sprockets, gears, pulleys, torque converters, clutches, belt drives, clutch drives and electric motors, must be fitted with scatter shields intended to contain drivetrain parts in case of failure.

T.5.2.2 The final drivetrain shield must:

- a. Be made with solid material (not perforated)
- b. Cover the chain or belt from the drive sprocket to the driven sprocket/chain wheel/belt or pulley.
- c. Start and end no higher than parallel to the lowest point of the chain wheel/belt/pulley:

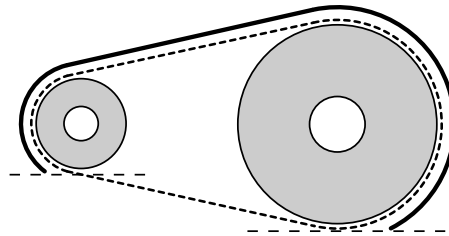

T.5.2.3 Body panels or other existing covers are acceptable when constructed per **T.5.2.7 / T.5.2.8**

T.5.2.4 Frame Members or existing components that exceed the scatter shield material requirements may be used as part of the shield.

T.5.2.5 Scatter shields may be composed of multiple pieces. Any gaps must be small (< 3 mm)

T.5.2.6 If equipped, the engine drive sprocket cover may be used as part of the scatter shield system.

T.5.2.7 Chain Drive - Scatter shields for chains must:

- a. Be made of 2.66 mm (0.105 inch) minimum thickness steel (no alternatives are allowed)
- b. Have a minimum width equal to three times the width of the chain
- c. Be centered on the center line of the chain
- d. Remain aligned with the chain under all conditions

T.5.2.8 Non-metallic Belt Drive - Scatter shields for belts must:

- a. Be made from 3.0 mm minimum thickness aluminum alloy 6061-T6
- b. Have a minimum width that is equal to 1.7 times the width of the belt.
- c. Be centered on the center line of the belt
- d. Remain aligned with the belt under all conditions.

T.5.2.9 Attachment Fasteners - All fasteners attaching scatter shields and guards must be 6mm or 1/4" minimum diameter **Critical Fasteners**, see **T.8.2**

T.5.2.10 Finger Guards

- a. Must cover any drivetrain parts that spin while the vehicle is stationary with the engine running.
- b. Must be made of material sufficient to resist finger forces.
- c. Mesh or perforated material may be used but must prevent the passage of a 12 mm diameter object through the guard.

T.5.3 Motor Protection (EV Only)

T.5.3.1 The rotating part of the Motor(s) **EV.5.1** must be contained in a structural casing.

The motor casing may be the original motor casing, a team built motor casing or the original casing with additional material added to achieve the minimum required thickness.

- Minimum thickness for aluminum alloy 6061-T6: 3.0 mm
If lower grade aluminum alloy is used, then the material must be thicker to provide an equivalent strength.
- Minimum thickness for steel: 2.0 mm

T.5.3.2 A Scatter Shield must be included around the Motor(s) when one or both:

- The motor casing rotates around the stator
- The motor case is perforated

T.5.3.3 The Motor Scatter Shield must be:

- Made from aluminum alloy 6061-T6 or steel
- Minimum thickness: 1.0 mm

T.5.4 Coolant Fluid

T.5.4.1 Water cooled engines must use only plain water with no additives of any kind.

T.5.4.2 Coolant for electric motors, accumulators or HV electronics must be one of:

- plain water with no additives
- oil

T.5.5 System Sealing

T.5.5.1 Any cooling or lubrication system must be sealed to prevent leakage.

T.5.5.2 The vehicle must be capable of being tilted to a 45° angle without leaking fluid of any type.

T.5.5.3 Flammable liquid leaks must not be allowed to accumulate.

T.5.5.4 Two or more holes of minimum diameter 25 mm each must be provided in the lowest part of the structure or belly pan in such a way as to prevent accumulation of liquids and/or vapors.

T.5.5.5 Absorbent material and open collection devices (regardless of material) are prohibited in compartments containing engine, drivetrain, exhaust and fuel systems below the highest point on the exhaust system.

T.5.6 Catch Cans

T.5.6.1 Separate catch cans must be used to retain fluids from any vents for the engine coolant system and engine lubrication system.

Each catch can must have a minimum capacity of 10% of the fluid being contained or 0.9 liter, whichever is greater.

- T.5.6.2 Any vent on other systems containing liquid lubricant or coolant, including a differential, gearbox, or electric motor, must have a catch can with a minimum capacity of 10% of the fluid being contained or 0.5 liter, whichever is greater.
- T.5.6.3 Catch cans must be:
- Capable of containing boiling water without deformation
 - Located rearwards of the Firewall below the driver's shoulder level
 - Positively retained, using no tie wraps or tape
- T.5.6.4 Any catch can on the cooling system must vent through a hose with a minimum internal diameter of 3 mm down to the bottom levels of the Chassis.

T.6 PRESSURIZED SYSTEMS

T.6.1 Compressed Gas Cylinders and Lines

Any system on the vehicle that uses a compressed gas as an actuating medium must meet the following:

- T.6.1.1 Working Gas - The working gas must be non flammable
- T.6.1.2 Cylinder Certification - The gas cylinder/tank must be commercially manufactured, designed and built for the pressure being used, certified by an accredited testing laboratory in the country of its origin, and labeled or stamped appropriately.
- T.6.1.3 Pressure Regulation - The pressure regulator must be mounted directly onto the gas cylinder/tank.
- T.6.1.4 Protection – The gas cylinder/tank and lines must be protected from rollover, collision from any direction, or damage resulting from the failure of rotating equipment.
- T.6.1.5 The driver must be protected from failure of the cylinder/tank and regulator.
- T.6.1.6 Cylinder Location - The gas cylinder/tank and the pressure regulator must be:
- Located outside of the Cockpit
 - One or both of:
 - Inside the Primary Structure Envelope
 - Protected by structure meeting **F.5.15 Component Protection**
- T.6.1.7 Cylinder Mounting - The gas cylinder/tank must be securely mounted on a path to the Chassis
- T.6.1.8 Cylinder Axis - The axis of the gas cylinder/tank must not point at the driver.
- T.6.1.9 Insulation - The gas cylinder/tank must be insulated from any heat sources
- T.6.1.10 Lines and Fittings - The gas lines and fittings must be appropriate for the maximum possible operating pressure of the system.

T.6.2 High Pressure Hydraulic Pumps and Lines

This section T.6.2 does not apply to Brake lines or hydraulic clutch lines

- T.6.2.1 The driver and anyone standing outside the vehicle must be shielded from any hydraulic pumps and lines with line pressures of 2100 kPa or higher.
- T.6.2.2 The shields must be steel or aluminum with a minimum thickness of 1 mm.

T.7 BODYWORK AND AERODYNAMIC DEVICES

T.7.1 Aerodynamic Devices

T.7.1.1 Aerodynamic Device

A part on the vehicle which guides airflow for purposes including generation of downforce and/or change of drag.

Examples include but are not limited to: wings, undertray, splitter, endplates, vanes

T.7.1.2 No power device may be used to move or remove air from under the vehicle. Power ground effects are strictly prohibited.

T.7.1.3 All Aerodynamic Devices must meet:

- a. The mounting system provides sufficient rigidity in the static condition
- b. The Aerodynamic Devices do not oscillate or move excessively when the vehicle is moving. Refer to **IN.8.2**

T.7.1.4 All forward facing edges that could contact a pedestrian (wings, end plates, and undertrays) must have a minimum radius of 5 mm for all horizontal edges and 3 mm for vertical edges.

This may be the radius of the edges themselves, or additional permanently attached pieces designed to meet this requirement.

T.7.1.5 Other edges that a person may touch must not be sharp

T.7.2 Bodywork

T.7.2.1 Conventionally designed Bodywork or a nose cone is not considered an Aerodynamic Device

T.7.2.2 Bodywork, a nose cone, or another component mounted to the vehicle is an Aerodynamic Device if is designed to, or may possibly, produce force due to aerodynamic effects

T.7.2.3 Bodywork must not contain openings into the Cockpit from the front of the vehicle back to the Main Hoop or Firewall. The cockpit opening and minimal openings around the front suspension components are allowed.

T.7.2.4 All forward facing edges on the Bodywork that could contact people, including the nose, must have forward facing radii minimum 38 mm. This minimum radius must extend 45° or more relative to the forward direction, along the top, sides and bottom of all affected edges.

T.7.3 Measurement

T.7.3.1 All Aerodynamic Device limitations are measured:

- a. With the wheels pointing in the straight ahead position
- b. Without a driver in the vehicle

*The intent is to standardize the measurement, see **GR.4.4.1***

T.7.3.2 Any part of any Aerodynamic Device or Bodywork must meet **V.1.1**

T.7.3.3 Head Restraint Plane

A transverse vertical plane through the rearmost portion of the front face of the driver head restraint support, excluding any padding, set (if adjustable) in its fully rearward position

T.7.4 Length

In plan view, any part of any Aerodynamic Device must be:

- a. No more than 700 mm forward of the fronts of the front tires
- b. No more than 250 mm rearward of the rear of the rear tires

T.7.5 Width

In plan view, any part of any Aerodynamic Device must be:

T.7.5.1 When forward of the centerline of the front wheel axles:

Inboard of two vertical planes parallel to the centerline of the chassis touching the outside of the front tires at the height of the hubs.

T.7.5.2 When between the centerlines of the front and rear wheel axles:

Inboard of a line drawn connecting the outer surfaces of the front and rear tires at the height of the wheel centers

T.7.5.3 When rearward of the **Head Restraint Plane**:

Inboard of two vertical planes parallel to the centerline of the chassis touching the inside of the rear tires at the height of the hub centerline.

T.7.6 Height

T.7.6.1 Any part of any Aerodynamic Device that is located:

- Rearward of the **Head Restraint Plane** must be no higher than 1200 mm above the ground.
- Forward of the **Head Restraint Plane** must be no higher than 500 mm above the ground.
- Forward of the centerline of the front wheel axles and Outboard of two vertical planes parallel to the centerline of the chassis touching the inside of the front tires at the height of the hubs must be no higher than 250 mm above the ground

T.7.6.2 Bodywork height is not restricted when the Bodywork is located:

- Between the transverse vertical planes positioned at the front and rear axle centerlines
- Inside two vertical fore and aft planes 400 mm outboard from the centerline on each side of the vehicle

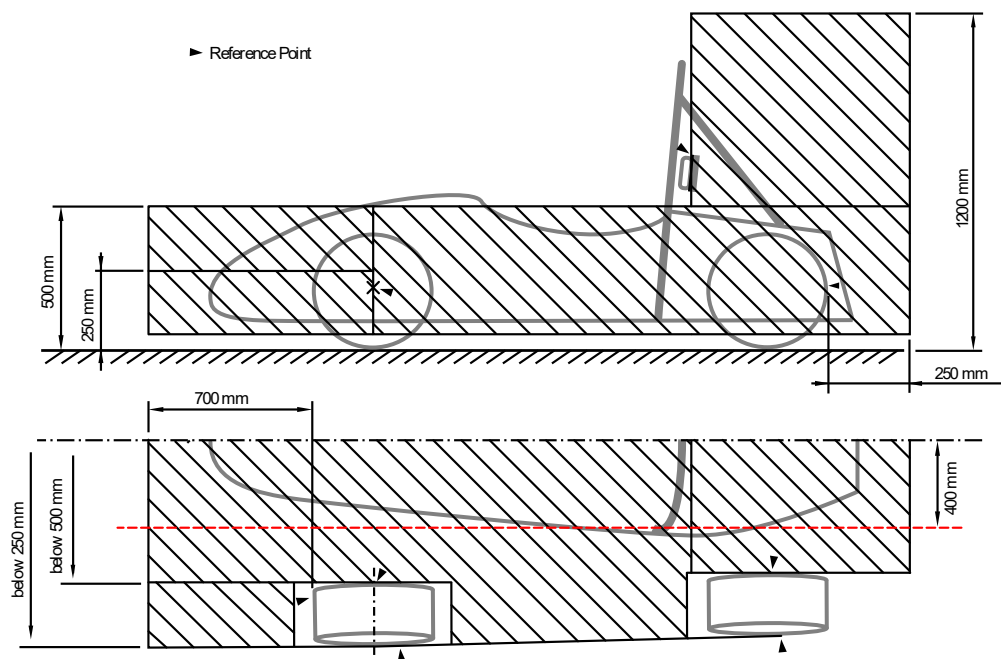

T.8 FASTENERS

T.8.1 Critical Fasteners

A fastener (bolt, screw, pin, etc) used in a location designated as such in the applicable rule

T.8.2 Critical Fastener Requirements

T.8.2.1 Any Critical Fastener must meet, at minimum, one of the following:

- a. SAE Grade 5
- b. Metric Grade 8.8
- c. AN/MS Specifications
- d. Equivalent to or better than above, as approved by a Rules Question or at Technical Inspection

T.8.2.2 All threaded Critical Fasteners must be one of the following:

- Hex head
- Hexagonal recessed drive (Socket Head Cap Screws or Allen screws/bolts)

T.8.2.3 All Critical Fasteners must be secured from unintentional loosening by the use of **Positive Locking Mechanisms** see **T.8.3**

T.8.2.4 A minimum of two full threads must project from any lock nut.

T.8.2.5 Some Critical Fastener applications have additional requirements that are provided in the applicable section.

T.8.3 Positive Locking Mechanisms

T.8.3.1 Positive Locking Mechanisms are defined as those which:

- a. Technical Inspectors / team members can see that the device/system is in place (visible).
- b. Do not rely on the clamping force to apply the locking or anti vibration feature.

Meaning If the fastener begins to loosen, the locking device still prevents the fastener coming completely loose

T.8.3.2 Examples of acceptable Positive Locking Mechanisms include, but are not limited to:

- a. Correctly installed safety wiring
- b. Cotter pins
- c. Nylon lock nuts (where temperature does not exceed 80°C)
- d. Prevailing torque lock nuts

Lock washers, bolts with nylon patches and thread locking compounds (Loctite®), DO NOT meet the positive locking requirement.

T.8.4 Requirements for All Fasteners

Adjustable tie rod ends must be constrained with a jam nut to prevent loosening.

T.9 ELECTRICAL EQUIPMENT

T.9.1 Definitions

T.9.1.1 High Voltage – HV

Any voltage greater than 60 V DC or 25 V AC RMS

T.9.1.2 Low Voltage - LV

Any voltage below and including 60 V DC or 25 V AC RMS

T.9.1.3 Normally Open

A type of electrical relay or contactor that allows current flow only in the energized state

T.9.2 Low Voltage Batteries

T.9.2.1 All Low Voltage Batteries and onboard power supplies must be attached securely to the Chassis.

T.9.2.2 All Low Voltage batteries must have Overcurrent Protection that trips at or below the maximum specified discharge current of the cells.

T.9.2.3 The hot (ungrounded) terminal must be insulated.

T.9.2.4 Any wet cell battery located in the driver compartment must be enclosed in a nonconductive marine type container or equivalent.

T.9.2.5 Batteries or battery packs based on lithium chemistry must meet one of the two:

- a. Have a rigid, sturdy casing made from **Nonflammable Material**
- b. A commercially available battery designed as an OEM style replacement

T.9.2.6 All batteries using chemistries other than lead acid must be presented at Technical Inspection with markings identifying it for comparison to a datasheet or other documentation proving the pack and supporting electronics meet all rules requirements

T.9.3 Master Switches

Each Master Switch (**IC.9.3** / **EV.8.9**) must meet the following:

T.9.3.1 Location

- a. On the driver's right hand side of the vehicle
- b. In proximity to the Main Hoop
- c. At the driver's shoulder height
- d. Able to be easily actuated from outside the vehicle

T.9.3.2 Characteristics

- a. Be of the rotary mechanical type
- b. Be rigidly mounted to the vehicle and must not be removed during maintenance
- c. Mounted where the rotary axis of the key is near horizontal and across the vehicle
- d. The ON position must be in the horizontal position and must be marked accordingly
- e. The OFF position must be clearly marked
- f. (EV Only) Operated with a red removable key that must only be removable in the electrically open position

T.9.4 Inertia Switch

T.9.4.1 Inertia Switch Requirement

- (EV) Must have an Inertia Switch
- (IC) Should have an Inertia Switch

T.9.4.2 The Inertia Switch must be:

- a. A Sensata Resettable Crash Sensor or equivalent

- b. Mechanically and rigidly attached to the vehicle
- c. Removable to test functionality

T.9.4.3 Inertia Switch operation:

- a. Must trigger due to an impact load which decelerates the vehicle at between 8 g and 11 g depending on the duration of the deceleration (refer to spec sheet of the Sensata device)
- b. Must Open the Shutdown Circuit **IC.9.2.2** / **EV.8.2.2** if triggered
- c. Must latch until manually reset
- d. May be reset by the driver from inside the driver's cell

VE - VEHICLE AND DRIVER EQUIPMENT

VE.1 VEHICLE IDENTIFICATION

VE.1.1 Vehicle Number

VE.1.1.1 The assigned vehicle number must appear on the vehicle as follows:

- a. Locations: in three places, on the front of the chassis and both sides
- b. Height: 150 mm minimum
- c. Font: Block numbers (sans serif characters without italic, outline, shadow, or cursive numbers)
- d. Stroke Width and Spacing between numbers: 18 mm minimum
- e. Color: White numbers on a black background OR black numbers on a white background
- f. Background: round, oval, square or rectangular
- g. Spacing: 25 mm minimum between the edge of the numbers and the edge of the background
- h. The numbers must not be obscured by parts of the vehicle

VE.1.1.2 Additional letters or numerals must not show before or after the vehicle number

VE.1.2 School Name

Each vehicle must clearly display the school name.

- a. Abbreviations are allowed if unique and generally recognized
- b. The name must be in Roman characters minimum 50 mm high on both sides of the vehicle.
- c. The characters must be placed on a high contrast background in an easily visible location.
- d. The school name may also appear in non Roman characters, but the Roman character version must be uppermost on the sides.

VE.1.3 SAE Logo

The SAE International Logo must be displayed on the front and/or both sides of the vehicle in a prominent location.

VE.1.4 Inspection Sticker

The vehicle must have space for the Inspection Sticker(s) **IN.13.2** that is:

- A clear and unobstructed area, minimum 25 cm wide x 20 cm high
- Located on the upper front surface of the nose along the vehicle centerline

VE.1.5 Transponder

VE.1.5.1 Each vehicle must have a functional, properly mounted transponder of the specified type(s).

VE.1.5.2 Vehicles without a transponder may not be allowed to compete in any event for which a transponder is used.

VE.1.5.3 The approved transponder type(s) and mounting details will be provided on the FSAE Online Website or by the organizer

VE.2 VEHICLE EQUIPMENT

VE.2.1 Jacking Point

VE.2.1.1 A Jacking Point must be provided at the rear of the vehicle

VE.2.1.2 The Jacking Point must be:

- a. Capable of supporting the vehicle weight and of engaging the organizer Quick Jacks
- b. Visible to a person standing 1 m behind the vehicle
- c. Color: Orange
- d. Oriented horizontally and perpendicular to the centerline of the vehicle
- e. Made from round, 25 - 30 mm OD aluminum or steel tube
- f. Exposed around the lower 180° of its circumference over a minimum length of 280 mm
- g. Access from the rear of the tube must be unobstructed for 300 mm or more of its length
- h. The height of the tube must allow 75 mm minimum clearance from the bottom of the tube to the ground
- i. When the vehicle is raised to where the bottom of the tube is 200 mm above ground, the wheels do not touch the ground when they are in full rebound

VE.2.2 Push Bar

Each vehicle must have a removable device which attaches to the rear of the vehicle that:

- a. Allows two people, standing erect behind the vehicle, to push the vehicle around the competition site
- b. Is capable of slowing and stopping the forward motion of the vehicle and pulling it rearwards

VE.2.3 Fire Extinguisher

VE.2.3.1 Each team must have two or more fire extinguishers.

- a. One extinguisher must readily be available in the team's paddock area
- b. One extinguisher must accompany the vehicle when moved using the push bar
A commercially available on board fire system may be used instead of the fire extinguisher that accompanies the vehicle

VE.2.3.2 Hand held fire extinguishers must NOT be mounted on or in the vehicle

VE.2.3.3 Each fire extinguisher must meet the following:

- a. Capacity: 0.9 kg (2 lbs)
- b. Working Medium: Dry chemical/dry powder. Aqueous Film Forming Foam (AFFF) and Halon extinguishers and systems are prohibited.
- c. Equipped with a manufacturer installed pressure/charge gauge.
- d. Minimum acceptable ratings:
 - USA, Canada & Brazil: 10BC or 1A 10BC
 - Europe: 34B or 5A 34B
 - Australia: 20BE or 1A 10BE
- e. Extinguishers of larger capacity (higher numerical ratings) are acceptable.

VE.2.4 Electrical Equipment (EV Only)

The following items must accompany the vehicle at all times:

- Two pairs of High Voltage insulating gloves
- A multimeter

VE.2.5 Camera Mounts

VE.2.5.1 The mounts for video/photographic cameras must be of a safe and secure design.

VE.2.5.2 All camera installations must be approved at Technical Inspection.

VE.2.5.3 Helmet mounted cameras and helmet camera mounts are prohibited.

VE.2.5.4 The body of a camera or recording unit that weighs more than 0.25 kg must be secured at a minimum of two points on different sides of the camera body.

VE.2.5.5 If a tether is used to restrain the camera, the tether length must be limited to prevent contact with the driver.

VE.3 DRIVER EQUIPMENT

VE.3.1 General

VE.3.1.1 Any Driver Equipment:

- a. Must be in good condition with no tears, rips, open seams, areas of significant wear, abrasions or stains which might compromise performance.
- b. Must fit properly
- c. May be inspected at any time

VE.3.1.2 Flame Resistant Material

For this section some, but not all, of the approved materials are: Carbon X, Indura, Nomex, Polybenzimidazole (common name PBI) and Proban.

VE.3.1.3 Synthetic Material – Prohibited

Shirts, socks or other undergarments (not to be confused with flame resistant underwear) made from nylon or any other synthetic material which could melt when exposed to high heat are prohibited.

VE.3.1.4 Officials may impound any non approved Driver Equipment until the end of the competition.

VE.3.2 Helmet

VE.3.2.1 The driver must wear a helmet which:

- a. Is closed face with an integral, immovable chin guard
- b. Contains an integrated visor/face shield supplied with the helmet
- c. Meets an approved standard
- d. Is properly labeled for that standard

VE.3.2.2 Acceptable helmet standards are listed below. Any additional approved standards are shown on the Technical Inspection Form or the FAQ on the FSAE Online website.

- a. [Snell](#) K2010, K2015, K2020, M2010, M2015, M2020, SA2010, SAH2010, SA2015, SA2020
- b. [SFI Specs](#) 31.1/2010, 31.1/2015, 41.1/2010, 41.1/2015
- c. [FIA Standards](#) FIA 8860-2004, FIA 8860-2010, FIA 8860-2018, FIA 8859-2015

VE.3.3 Driver Gear

The driver must wear the following:

VE.3.3.1 Driver Suit

A one piece suit, made from a minimum of two layers of **Flame Resistant Material** that covers the body from the neck to the ankles and the wrists.

Each suit must meet one or more of the following standards and be labeled as such:

- [SFI 3.2A/5](#) (or higher ex: /10, /15, /20)
- [SFI 3.4/5](#) (or higher ex: /10, /15, /20)
- FIA Standard 1986
- [FIA Standard 8856-2000](#)
- [FIA Standard 8856-2018](#)

VE.3.3.2 Underclothing

All competitors should wear fire retardant underwear (long pants and long sleeve shirt) under their approved Driver Suit.

VE.3.3.3 Balaclava

A Balaclava (head sock) which covers the driver's head, hair and neck, made from **Flame Resistant Material**

VE.3.3.4 Socks

Socks made from **Flame Resistant Material** that cover the bare skin between the driver's suit and the Shoes.

VE.3.3.5 Shoes

Shoes or boots made from **Flame Resistant Material** that meet an approved standard and labeled as such:

- [SFI Spec 3.3](#)
- [FIA Standard 8856-2000](#)
- [FIA Standard 8856-2018](#)

VE.3.3.6 Gloves

Gloves made from **Flame Resistant Material**.

Gloves of all leather construction or fire retardant gloves constructed using leather palms with no insulating **Flame Resistant Material** underneath are not acceptable.

VE.3.3.7 Arm Restraints

- a. Arm restraints must be worn in a way that the driver can release them and exit the vehicle unassisted regardless of the vehicle's position.
- b. Arm restraints must be commercially manufactured. Arm restraints certified to [SFI Spec 3.3](#) and labeled as such meet this requirement.

IC - INTERNAL COMBUSTION ENGINE VEHICLES

IC.1 GENERAL REQUIREMENTS

IC.1.1 Engine Limitations

IC.1.1.1 The engine(s) used to power the vehicle must:

- a. Be a piston engine(s) using a four stroke primary heat cycle
- b. Have a total combined displacement less than or equal to **710 cc** per cycle.

IC.1.1.2 Hybrid powertrains, such as those using electric motors running off stored energy, are prohibited.

IC.1.1.3 All waste/rejected heat from the primary heat cycle may be used. The method of conversion is not limited to the four stroke cycle.

IC.1.1.4 The engine may be modified within the restrictions of the rules.

IC.1.2 Air Intake and Fuel System Location

All parts of the engine air system and fuel control, delivery and storage systems (including the throttle or carburetor, and the complete air intake system, including the air cleaner and any air boxes) must lie inside the **Tire Surface Envelope F.1.14**

IC.2 AIR INTAKE SYSTEM

IC.2.1 General

IC.2.2 Intake System Location

IC.2.2.1 The Intake System must meet **IC.1.2**

IC.2.2.2 Any portion of the air intake system that is less than 350 mm above the ground must be shielded from side or rear impacts by structure built per **F.6.4 / F.7.6** as applicable.

IC.2.3 Intake System Mounting

IC.2.3.1 The intake manifold must be securely attached to the engine block or cylinder head with brackets and mechanical fasteners. Hose clamps, plastic ties, or safety wires do not meet this requirement.

The use of rubber bushings or hose is acceptable for creating and sealing air passages, but is not a structural attachment.

IC.2.3.2 Threaded fasteners used to secure and/or seal the intake manifold must have a Positive Locking Mechanism, see **T.8.3**.

IC.2.3.3 Intake systems with significant mass or cantilever from the cylinder head must be supported to prevent stress to the intake system.

- a. Supports to the engine must be rigid.
- b. Supports to the Chassis must incorporate some isolation to allow for engine movement and chassis flex.

IC.2.4 Intake System Restrictor

IC.2.4.1 All airflow to the engine(s) must pass through a single circular restrictor placed in the intake system.

IC.2.4.2 The only allowed sequence of components are the following:

- a. For naturally aspirated engines, the sequence must be: throttle body, restrictor, and engine.
- b. For turbocharged or supercharged engines, the sequence must be: restrictor, compressor, throttle body, engine.

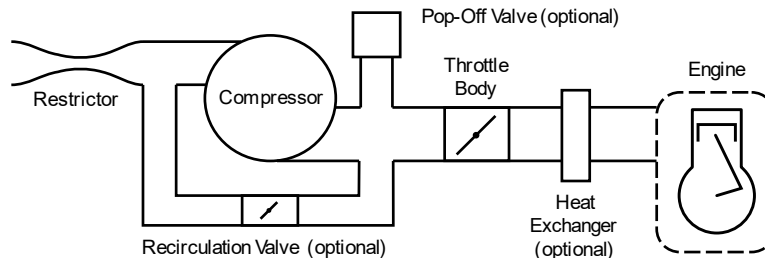

IC.2.4.3 The maximum restrictor diameters at any time during the competition are:

- a. Gasoline fueled vehicles 20.0 mm
- b. E85 fueled vehicles 19.0 mm

IC.2.4.4 The restrictor must be located to facilitate measurement during Technical Inspection

IC.2.4.5 The circular restricting cross section must NOT be movable or flexible in any way

IC.2.4.6 The restrictor must not be part of the movable portion of a barrel throttle body.

IC.2.5 Turbochargers & Superchargers

IC.2.5.1 The intake air may be cooled with an intercooler (a charge air cooler).

- a. It must be located downstream of the throttle body
- b. Only ambient air may be used to remove heat from the intercooler system
- c. Air to air and water to air intercoolers are permitted
- d. The coolant of a water to air intercooler system must meet **T.5.4.1**

IC.2.5.2 If pop-off valves, recirculation valves, or heat exchangers (intercoolers) are used, they must be positioned in the intake system as shown in **IC.2.4.2.b**

IC.2.5.3 Plenums must not be located anywhere upstream of the throttle body

For the purpose of definition, a plenum is any tank or volume that is a significant enlargement of the normal intake runner system. Teams may submit their designs via a Rules Question for review prior to competition if the legality of their proposed system is in doubt.

IC.2.5.4 The maximum allowable area of the inner diameter of the intake runner system between the restrictor and throttle body is 2825 mm²

IC.2.6 Connections to Intake

Any crankcase or engine lubrication vent lines routed to the intake system must be connected upstream of the intake system restrictor.

IC.3 THROTTLE

IC.3.1 General

- IC.3.1.1 The vehicle must have a carburetor or throttle body.
 - a. The carburetor or throttle body may be of any size or design.
 - b. Carburetors must not be used on boosted applications.
- IC.3.1.2 The foot pedal must return to its original position when not actuated
- IC.3.1.3 A positive pedal stop must be incorporated on the throttle pedal to prevent over stressing the throttle cable or actuation system.
- IC.3.1.4 If the throttle system contains any mechanism that could become jammed, for example a gear mechanism, then this must be covered to prevent ingress of any debris.

IC.3.2 Throttle Actuation Method

The throttle may be actuated:

- a. Mechanically by a cable or rod system
- b. By Electronic Throttle Control

IC.3.3 Throttle Actuation – Mechanical

- IC.3.3.1 The throttle cable or rod must:
 - a. Have smooth operation
 - b. Have no possibility of binding or sticking.
 - c. Be minimum 50 mm from any exhaust system component and out of the exhaust stream.
 - d. Be protected from being bent or kinked by the driver's foot when it is operated by the driver or when the driver enters or exits the vehicle.
- IC.3.3.2 The throttle actuation system must use two or more return springs located at the throttle body. Failure of any component of the throttle system will not prevent the throttle returning to the closed position.
Throttle Position Sensors (TPS) are NOT acceptable as return springs.

IC.4 ELECTRONIC THROTTLE CONTROL

This section IC.4 applies only when Electronic Throttle Control is used

An Electronic Throttle Control (ETC) system may be used. This is a device or system which may change the engine throttle setting based on various inputs.

IC.4.1 General Design

- IC.4.1.1 The electronic throttle must automatically close (return to idle) when power is removed.
- IC.4.1.2 The electronic throttle must use minimum two sources of energy capable of returning the throttle to the idle position.
 - a. One of the sources may be the device (such as a DC motor) that normally actuates the throttle
 - b. The other device(s) must be a throttle return spring that can return the throttle to the idle position if loss of actuator power occurs.
 - c. Springs in the TPS are not acceptable throttle return springs

IC.4.1.3 The ETC system may blip the throttle during downshifts when proven that unintended acceleration can be avoided. The functional analysis must be documented in the FMEA.

IC.4.2 Commercial ETC System

IC.4.2.1 An ETC system that is commercially available, but does not comply with the regulations, may be used, if approved prior to the event.

IC.4.2.2 To obtain approval, submit a Rules Question which includes:

- Which ETC system the team is seeking approval to use.
- The specific ETC rule(s) that the commercial system deviates from.
- Sufficient technical details of these deviations to determine the acceptability of the commercial system.

IC.4.3 Documentation

IC.4.3.1 The ETC Notice of Intent:

- Must be submitted to inform the organizer of the intent to run ETC
- May be used to screen which teams are allowed to use ETC

IC.4.3.2 The Failure Modes and Effects Analysis – FMEA must be submitted in order to use ETC

IC.4.3.3 Submit the ETC Notice of Intent and ETC - FMEA as given in section **DR - Document Requirements**

IC.4.3.4 Late or non submission will prevent use of ETC, see **DR.3.4.1**

IC.4.4 Throttle Position Sensor - TPS

IC.4.4.1 The TPS must measure the position of the throttle or the throttle actuator.

Throttle position is defined as percent of travel from fully closed to wide open where 0% is fully closed and 100% is fully open.

IC.4.4.2 Two or more separate sensors must be used as TPSs. The TPSs may share the same supply and reference lines only if effects of supply and/or reference line voltage offsets can be detected.

IC.4.4.3 Implausibility is defined as a deviation of more than 10% throttle position between the sensors or other failure as defined in Section **IC.4**. Use of larger values may be considered on a case by case basis and require justification in the FMEA.

IC.4.4.4 If an implausibility occurs between the values of the two TPSs and persists for more than 100 msec, the power to the electronic throttle must be immediately shut down.

IC.4.4.5 If three sensors are used, then in the case of a TPS failure, any two TPSs that agree within 10% throttle position may be used to define the throttle position target and the 3rd TPS may be ignored.

IC.4.4.6 Each TPS must be able to be checked during Technical Inspection by having one of:

- a. A separate detachable connector(s) for any TPS signal(s) to the main ECU without affecting any other connections
- b. An inline switchable breakout box available that allows disconnection of each TPS signal(s) to the main ECU without affecting any other connections

IC.4.4.7 The TPS signals must be sent directly to the throttle controller using an analogue signal or via a digital data transmission bus such as CAN or FlexRay. Any failure of the TPSs or TPS wiring must be detectable by the controller and must be treated like implausibility.

IC.4.4.8 When an analogue signal is used, the TPSs will be considered to have failed when they achieve an open circuit or short circuit condition which generates a signal outside of the normal operating range, for example $<0.5\text{ V}$ or $>4.5\text{ V}$. The circuitry used to evaluate the sensor must use pull down or pull up resistors to ensure that open circuit signals result in a failure being detected.

IC.4.4.9 When any kind of digital data transmission is used to transmit the TPS signal,

- The FMEA study must contain a detailed description of all the potential failure modes that can occur, the strategy that is used to detect these failures and the tests that have been conducted to prove that the detection strategy works.
- The failures to be considered must include but are not limited to the failure of the TPS, TPS signals being out of range, corruption of the message and loss of messages and the associated time outs.

IC.4.5 Accelerator Pedal Position Sensor - APPS

Refer to **T.4.2** for specific requirements of the APPS

IC.4.6 Brake System Encoder - BSE

Refer to **T.4.3** for specific requirements of the BSE

IC.4.7 Plausibility Checks

IC.4.7.1 Brakes and Throttle Position

- The power to the electronic throttle must be shut down if the mechanical brakes are actuated and the TPS signals that the throttle is open by more than a permitted amount for more than one second.
- An interval of one second is allowed for the throttle to close (return to idle). Failure to achieve this in the required interval must result in immediate shut down of fuel flow and the ignition system.
- The permitted relationship between BSE and TPS may be defined by the team using a table, but the functionality must be demonstrated at Technical Inspection.

IC.4.7.2 Throttle Position vs Target

- The power to the electronic throttle must be immediately shut down, if throttle position differs by more than 10% from the expected target TPS position for more than one second.
- An interval of one second is allowed for the difference to reduce to less than 10%, failure to achieve this in the required interval must result in immediate shut down of fuel flow and the ignition system.
- An error in TPS position and the resultant system shutdown must be demonstrated at Technical Inspection.

Teams must have a method to demonstrate that the actions in **IC.4.7.2.b above** are met. System states displayed using calibration software must be accompanied by a detailed explanation of the control system.

IC.4.7.3 The electronic throttle and fuel injector/ignition system shutdown must remain active until the TPS signals indicate the throttle is at or below the unpowered default position for one second or longer.

IC.4.8 Brake System Plausibility Device - BSPD

IC.4.8.1 A standalone nonprogrammable circuit must be used to monitor the electronic throttle control.

The BSPD must be provided in addition to the plausibility checks in the ETC which interpret the drivers throttle request and control the engine throttle position.

IC.4.8.2 Signals from any sensors must be sent directly to the BSPD. Outputs from other modules may not be used in place of the raw sensor signals.

IC.4.8.3 The BSPD must monitor for the following conditions:

- a. Both of the following for more than one second:
 - Hard braking (for example >0.8 g deceleration but without locking the wheels)
 - Throttle greater than 10% open
- b. Loss of signal from the braking sensor(s) for more than 100 msec
- c. Loss of signal from the throttle sensor(s) for more than 100 msec
- d. Removal of power from the BSPD circuit

IC.4.8.4 When any of the above conditions exist, the BSPD must Open the Shutdown Circuit **IC.9.2.2**

IC.4.8.5 The BSPD must only be reset by cycling the Primary Master Switch **IC.9.3** OFF and ON

IC.4.8.6 The BSPD must not reset when the Cockpit Main Switch **IC.9.4** is turned OFF

IC.4.8.7 The BSPD signals and function must be able to be checked during Technical Inspection by having one of:

- a. A separate set of detachable connectors for any signals from the braking sensor(s), throttle sensor(s) and removal of power to only the BSPD device.
- b. An inline switchable breakout box available that allows disconnection of the brake sensor(s), throttle sensor(s) individually and power to only the BSPD device.

IC.5 FUEL AND FUEL SYSTEM

IC.5.1 Fuel

IC.5.1.1 Vehicles must be operated with the fuels provided by the organizer at the competition.

IC.5.1.2 Fuels provided are expected to be Gasoline and E85. Consult the individual competition websites for fuel specifics and other information.

IC.5.1.3 No agents other than the provided fuel and air may go into the combustion chamber.

IC.5.2 Fuel System

IC.5.2.1 The Fuel System must meet the following design criteria:

- a. The Fuel Tank is capable of being filled to capacity without manipulating the tank or the vehicle in any manner.
- b. During refueling on a level surface, the formation of air cavities or other effects that cause the fuel level observed at the sight tube to drop after movement or operation of the vehicle (other than due to consumption) are prevented.
- c. Spillage during refueling cannot contact the driver position, exhaust system, hot engine parts, or the ignition system.

IC.5.2.2 The Fuel System location must meet **IC.1.2** and **F.9**

IC.5.2.3 A Firewall must separate the Fuel Tank from the driver, per **T.1.8**

IC.5.3 Fuel Tank

The part(s) of the fuel containment device that is in contact with the fuel.

IC.5.3.1 Fuel Tanks made of a rigid material must:

- a. Be securely attached to the vehicle structure. The mounting method must not allow chassis flex to load the Fuel Tank.
- b. Not be used to carry any structural loads; from Roll Hoops, suspension, engine or gearbox mounts

IC.5.3.2 Any Fuel Tank that is made from a flexible material, for example a bladder fuel cell or a bag tank:

- a. Must be enclosed inside a rigid fuel tank container which is securely attached to the vehicle structure.
- b. The Fuel Tank container may be load carrying

IC.5.3.3 Any size Fuel Tank may be used.

IC.5.3.4 The Fuel Tank, by design, must not have a variable capacity.

IC.5.3.5 The Fuel System must have a provision for emptying the Fuel Tank if required.

IC.5.4 Fuel Filler Neck & Sight Tube

IC.5.4.1 All Fuel Tanks must have a Fuel Filler Neck which must be:

- a. Minimum 35 mm inner diameter at any point between the Fuel Tank and the Fuel Filler cap

IC.5.4.2 The portion of the Fuel Filler Neck nearest to the Fuel Filler cap must be:

- a. Minimum 125 mm vertical height above the top level of the Fuel Tank
- b. Angled no more than 30° from the vertical

IC.5.4.3 The Fuel Filler Neck must be accompanied by a clear fuel resistant sight tube for reading the fuel level which must be:

- a. Visible vertical height: 125 mm minimum
- b. Inside diameter: 6 mm minimum
- c. Above the top surface of the Fuel Tank

IC.5.4.4 A clear Fuel Filler Neck tube may be used as a sight tube, subject to approval by a Rules Question or technical inspectors at the event.

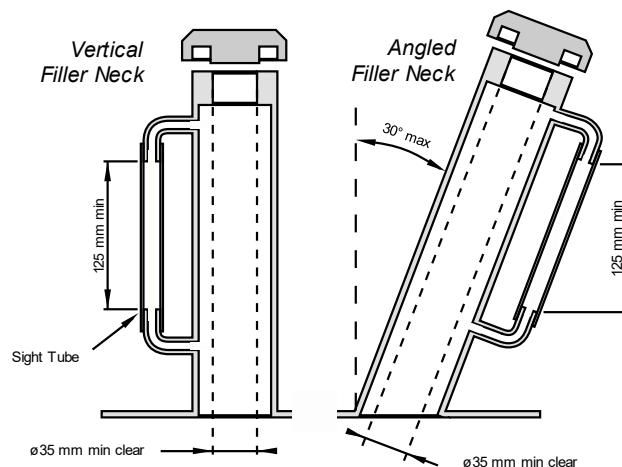

IC.5.4.5 **Fuel Level Line** - A permanent, non movable fuel level line must be located between 12 mm and 25 mm below the top of the visible portion of the sight tube.

This line will be used as the fill line for the Tilt Test, and before and after Endurance to measure the amount of fuel used during the Endurance Event.

IC.5.4.6 The sight tube and fuel level line must be clearly visible to two individuals (one to fill the tank, the other to visually verify fill) without the need of assistance (artificial lighting, magnifiers, etc) or the need to remove any parts (body panels, etc).

IC.5.4.7 The individual filling the tank must have complete direct access to the filler neck opening with a standard two gallon gas can assembly.

The gas can is minimum 25 cm wide x 25 cm deep x 35 cm high, with a 25 cm spout at the top

IC.5.4.8 The filler neck must have a fuel cap that can withstand severe vibrations or high pressures such as could occur during a vehicle rollover event

IC.5.5 Fuel Tank Filling

IC.5.5.1 During fueling or refueling the vehicle may only be touched by the fuel crew and officials.

IC.5.5.2 The tank will be filled to the fill line, or if a filling system is used, to the automatic stop point.

IC.5.5.3 If, for any reason, the fuel level changes after the team have moved the vehicle, then no additional fuel will be added, unless fueling after Endurance, see **D.13.2.5**

IC.5.6 Venting Systems

IC.5.6.1 Venting systems for the fuel tank and fuel delivery system must not allow fuel to spill during hard cornering or acceleration.

IC.5.6.2 All fuel vent lines must have a check valve to prevent fuel leakage when the tank is inverted.

IC.5.6.3 All fuel vent lines must exit outside the bodywork.

IC.5.7 Fuel Lines

IC.5.7.1 Fuel lines must be securely attached to the vehicle and/or engine.

IC.5.7.2 All fuel lines must be shielded from possible rotating equipment failure or collision damage.

IC.5.7.3 Plastic fuel lines between the fuel tank and the engine (supply and return) are prohibited.

IC.5.7.4 Any rubber fuel line or hose used must meet the following:

a. The components over which the hose is clamped must have annular bulb or barbed fittings to retain the hose

b. Clamps specifically designed for fuel lines must be used.

These clamps have three features: a full 360° wrap, a nut and bolt system for tightening, and rolled edges to prevent the clamp cutting into the hose

IC.5.7.5 Worm gear type hose clamps must not be used on any fuel line.

IC.6 FUEL INJECTION

IC.6.1 Low Pressure Injection (LPI)

Low Pressure fuel injection systems are those functioning at a pressure below 10 Bar. Most Port Fuel Injected (PFI) fuel systems are low pressure.

IC.6.1.1 Any Low Pressure flexible fuel lines must be one of:

- Metal braided hose with threaded fittings (crimped on or reusable)

- Reinforced rubber hose with some form of abrasion resistant protection

IC.6.1.2 Fuel rail and mounting requirements:

- a. Unmodified OEM Fuel Rails are acceptable, regardless of material.
- b. Non OEM fuel rails made from plastic, carbon fiber or rapid prototyping flammable materials are prohibited.
- c. The fuel rail must be securely attached to the manifold, engine block or cylinder head with brackets and mechanical fasteners.
Hose clamps, plastic ties, or safety wires do not meet this requirement.
- d. Threaded fasteners used to secure the fuel rail are **Critical Fasteners**, see **T.8.2**

IC.6.2 High Pressure Injection (HPI) / Direct Injection (DI)

IC.6.2.1 Definitions

- a. High Pressure fuel systems - those functioning at 10 Bar pressure or above
- b. Direct Injection fuel systems - where the injection occurs directly into the combustion system

Direct Injection systems often utilize a low pressure electric fuel pump and high pressure mechanical “boost” pump driven off the engine.

- c. High Pressure Fuel Lines - those between the boost pump and injectors
- d. Low Pressure Fuel Lines - from the electric supply pump to the boost pump

IC.6.2.2 All High Pressure Fuel Lines must:

- a. Be stainless steel rigid line or Aeroquip FC807 smooth bore PTFE hose with stainless steel reinforcement and visible Nomex tracer yarn. Equivalent products may be used with prior approval.
- b. Not incorporate elastomeric seals
- c. Be rigidly connected every 100 mm by mechanical fasteners to structural engine components such as cylinder heads or block

IC.6.2.3 Any Low Pressure flexible Fuel Lines must be one of:

- Metal braided hose with threaded fittings (crimped on or reusable)
- Reinforced rubber hose with some form of abrasion resistant protection

IC.6.2.4 Fuel rail mounting requirements:

- a. The fuel rail must be securely attached to the engine block or cylinder head with brackets and mechanical fasteners. Hose clamps, plastic ties, or safety wires do not meet this requirement.
- b. The fastening method must be sufficient to hold the fuel rail in place with the maximum regulated pressure acting on the injector internals and neglecting any assistance from cylinder pressure acting on the injector tip.
- c. Threaded fasteners used to secure the fuel rail are **Critical Fasteners**, see **T.8.2**

IC.6.2.5 High Pressure Fuel Pump – must be rigidly mounted to structural engine components such as the cylinder head or engine block.

IC.6.2.6 Pressure Regulator – must be fitted between the High Pressure and Low Pressure sides of the fuel system in parallel with the DI boost pump. The external regulator must be used even if the DI boost pump comes equipped with an internal regulator.

IC.7 EXHAUST AND NOISE CONTROL

IC.7.1 Exhaust Protection

IC.7.1.1 The exhaust system must be separated from any of the following components by means given in **T.1.6.3**:

- a. Flammable materials, including the fuel and fuel system, the oil and oil system
- b. Thermally sensitive components, including brake lines, composite materials, and batteries

IC.7.2 Exhaust Outlet

IC.7.2.1 The exhaust must be routed to prevent the driver from fumes at any speed considering the draft of the vehicle

IC.7.2.2 The Exhaust Outlet(s) must be:

- a. No more than 45 cm behind the centerline of the rear axle
- b. No more than 60 cm above the ground.

IC.7.2.3 Any exhaust components (headers, mufflers, etc.) that protrude from the side of the body in front of the Main Hoop must be shielded to prevent contact by persons approaching the vehicle or a driver exiting the vehicle

IC.7.2.4 Fibrous/absorbent material, (such as header wrap), must not be used on the outside of an exhaust manifold or exhaust system.

IC.7.3 Variable Exhaust

IC.7.3.1 Adjustable tuning or throttling devices are permitted.

IC.7.3.2 Manually adjustable tuning devices must require tools to change

IC.7.3.3 Refer to **IN.10.2** for additional requirements during the Noise Test

IC.7.4 Connections to Exhaust

Crankcase breathers that pass through the oil catch tank(s) to exhaust systems, or vacuum devices that connect directly to the exhaust system, are prohibited.

IC.7.5 Noise Level and Testing

IC.7.5.1 The vehicle must remain below the permitted sound level at all times **IN.10.5**

IC.7.5.2 Sound level will be verified during Technical Inspection, refer to **IN.10**

IC.8 ELECTRICAL

IC.8.1 Starter

Each vehicle must start the engine using an onboard starter at all times

IC.8.2 Batteries

Refer to **T.9.2** for specific requirements of Low Voltage batteries

IC.8.3 Voltage Limit

IC.8.3.1 Voltage between any two electrical connections must be Low Voltage **T.9.1.2**

IC.8.3.2 This voltage limit does not apply to the following systems:

- High Voltage systems for ignition
- High Voltage systems for injectors

- Voltages internal to OEM charging systems designed for <60 V DC output.

IC.9 SHUTDOWN SYSTEM

IC.9.1 Shutdown Circuit

IC.9.1.1 The Shutdown Circuit consists of the following components:

- a. Primary Master Switch **IC.9.3**
- b. Cockpit Main Switch **IC.9.4**
- c. (ETC Only) Brake System Plausibility Device (BSPD) **IC.4.8**
- d. Brake Overtravel Switch (BOTS) **T.3.2**
- e. Inertia Switch (if used) **T.9.4**

IC.9.1.2 The team must be able to demonstrate all features and functions of the Shutdown Circuit and components at Technical Inspection

IC.9.1.3 The international electrical symbol (a red spark on a white edged blue triangle) must be near both the Primary Master Switch and Cockpit Main Switch.

IC.9.2 Shutdown Circuit Operation

IC.9.2.1 The Shutdown Circuit must Open upon operation of, or detection from any of the components listed in **IC.9.1.1**

IC.9.2.2 When the Shutdown Circuit Opens, it must:

- a. Stop the engine
- b. Disconnect power to the:
 - Fuel Pump(s)
 - Ignition
 - (ETC only) Electronic Throttle **IC.4.1.1**

IC.9.3 Primary Master Switch

IC.9.3.1 Configuration and Location - The Primary Master Switch must meet **T.9.3**

IC.9.3.2 Function - the Primary Master Switch must:

- a. Disconnect power to ALL electrical circuits, including the battery, alternator, lights, fuel pump(s), ignition and electrical controls.
All battery current must flow through this switch
- b. Be direct acting, not act through a relay or logic.

IC.9.4 Cockpit Main Switch

IC.9.4.1 Configuration - The Cockpit Main Switch must:

- a. Be a push-pull or push-rotate emergency switch (pushing the button is the OFF position)
- b. Have a diameter of 24 mm minimum

IC.9.4.2 Location – The Cockpit Main Switch must be:

- a. In easy reach of the driver when in a normal driving position wearing Harness
- b. Adjacent to the Steering Wheel
- c. Unobstructed by the Steering Wheel or any other part of the vehicle

IC.9.4.3 Function - the Cockpit Main Switch may act through a relay

EV - ELECTRIC VEHICLES

EV.1 DEFINITIONS

EV.1.1 Tractive System – TS

Every part electrically connected to the Motor(s) and/or Accumulator(s)

EV.1.2 Grounded Low Voltage - GLV

Every electrical part that is not part of the Tractive System

EV.1.3 Accumulator

All the battery cells or super capacitors that store the electrical energy to be used by the Tractive System

EV.2 DOCUMENTATION

EV.2.1 Electrical System Form - ESF

EV.2.1.1 Each team must submit an Electrical System Form (ESF) with a clearly structured documentation of the entire vehicle electrical system (including control and Tractive System).

Submission and approval of the ESF does not mean that the vehicle will automatically pass Electrical Technical Inspection with the described items / parts.

EV.2.1.2 The ESF may provide guidance or more details than the Formula SAE Rules.

EV.2.1.3 Use the format provided and submit the ESF as given in section **DR - Document Requirements**

EV.2.2 Submission Penalties

Penalties for the ESF are imposed as given in section **DR - Document Requirements**.

EV.3 WORK PRACTICES

EV.3.1 Personnel

EV.3.1.1 The Electrical System Officer (ESO): **AD.5.2**

- a. Is the only person on the team that may declare the vehicle electrically safe to allow work on any system
- b. Must accompany the vehicle when operated or moved at the competition site
- c. Must be contactable by phone at all times during the event

EV.3.2 Maintenance

EV.3.2.1 Safety glasses with side shields must be worn by all participating team members any time when:

- a. Parts of the Tractive System are exposed while energized
- b. Work is performed on the Accumulators

EV.3.2.2 Appropriate insulated tools must be used when working on the Accumulator or Tractive System

EV.4 ELECTRICAL LIMITATIONS

EV.4.1 Power and Voltage

EV.4.1.1 The maximum power drawn from the Accumulator must not exceed **80 kW**.

EV.4.1.2 The maximum permitted voltage that may occur between any two points must not exceed **600 V DC**

EV.4.1.3 Regenerating energy is allowed and unrestricted when the vehicle speed is > 5 km/hr.

EV.4.1.4 Supplying power to the motor to drive the vehicle in reverse is prohibited.

EV.4.2 Energy Meter

EV.4.2.1 All Electric Vehicles must run with the Energy Meter provided by the organizer.

*Refer to the FSAEOnline Website **AD.2.2** for detail information on the Energy Meter.*

EV.4.2.2 The Energy Meter must be installed in an easily accessible location

EV.4.2.3 All power supplying the Tractive System must flow through the Energy Meter.

EV.4.2.4 Power and Voltage limits will be checked by the Energy Meter data.

Energy is calculated as the time integrated value of the measured voltage multiplied by the measured current logged by the Energy Meter.

EV.4.3 Violations

EV.4.3.1 A Violation occurs when one or both of the following exist:

- a. Use of more than the specified maximum power **EV.4.1.1**
- b. Exceed the maximum voltage **EV.4.1.2**

for one or both conditions:

- Continuously for 100 ms or more
- After a moving average over 500 ms is applied

EV.4.3.2 Missing Energy Meter data due to the team's fault, tampering, or attempting to tamper with the Energy Meter will be treated as a Violation.

EV.4.3.3 Tampering, or attempting to tamper with the Energy Meter or its data may result in Disqualification (DQ)

EV.4.4 Penalties

EV.4.4.1 Violations during the Acceleration, Skidpad, Autocross Events:

- a. Each run with one or more Violations will Disqualify (DQ) the best run of the team
- b. Multiple runs with Violations will DQ multiple runs, ex two runs with Violations DQ the two best runs

EV.4.4.2 Violations during the Endurance event:

- Each Violation: 60 second penalty **D.14.2.1**

EV.4.4.3 Repeated Violations may void Inspection Approval or receive additional penalties up to and including Disqualification, subject to official discretion.

EV.4.4.4 The respective data of each run in which a team has a Violation and the resulting decision may be made public.

EV.5 COMPONENTS

EV.5.1 Motors

EV.5.1.1 Only electrical motors are allowed. The number of motors is not limited.

EV.5.1.2 Motors must meet **T.5.3**

EV.5.1.3 If used, Outboard Wheel Motors, where the motor, attendant cables and wiring do not meet **F.11.1.3**, must:

- a. Include an Interlock **EV.8.8**

This Interlock(s) must Open the Shutdown Circuit **EV.8.2.2** before failure of the Tractive System wiring when the wiring is damaged or the Wheel/Motor assembly is damaged or knocked off the vehicle.

- b. Reduce the length of the portions of wiring and other connections that do not meet **F.11.1.3** to the extent possible

EV.5.2 Motor Controller

The Tractive System Motor(s) must be connected to the Accumulator through a Motor Controller. No direct connections between Motor(s) and Accumulator.

EV.5.3 Accumulator Container

EV.5.3.1 Accumulator Containers must meet **F.10**

EV.5.3.2 The Accumulator Container(s) must be removable from the vehicle while still remaining rules compliant.

EV.5.3.3 The Accumulator Container(s) must be completely closed at all times (when mounted to the vehicle and when removed from the vehicle) without the need to install extra protective covers.

EV.5.3.4 The Accumulator Container(s) may contain Holes or Openings.

- a. Only the wiring harness, ventilation, cooling and fasteners may pass through holes in the Accumulator Container(s)
- b. Holes and Openings in the Accumulator Container must meet **F.10.4**
- c. External holes must meet **EV.7.1**

EV.5.3.5 Any Accumulators that may vent an explosive gas must have a ventilation system or pressure relief valve to prevent the vented gas from reaching an explosive concentration.

EV.5.3.6 Completely sealed Accumulator Containers must have a pressure relief valve to prevent high pressure in the container.

EV.5.3.7 Each Accumulator Container must be labeled with the:

- a. Symbol specified in [ISO 7010-W012](#) (triangle with black lightning bolt on yellow background) with triangle side length of 100 mm minimum
- b. Text “Always Energized”
- c. Text “High Voltage” if the voltage meets **T.9.1.1**

EV.5.4 Grounded Low Voltage System

EV.5.4.1 The GLV System must be a Low Voltage system that is Grounded to the Chassis

EV.5.4.2 The GLV System must include a Master Switch, see **EV.8.9.1**

EV.5.4.3 A GLV Measuring Point (GLVMP) must be installed which is:

- a. Connected to GLV System Ground
- b. Next to the TSMP **EV.6.8**
- c. 4 mm shrouded banana jack
- d. Color: Black

e. Marked “GND”

EV.5.4.4 Low Voltage Batteries must meet **T.9.2**

EV.5.5 Accelerator Pedal Position Sensor - APPS

EV.5.5.1 Refer to **T.4.2** for specific requirements of the APPS

EV.5.5.2 Drive by wire control of wheel torque is permitted.

EV.5.5.3 Any algorithm or electronic control unit that can adjust the requested wheel torque may only lower the total driver requested torque and must not increase it.

EV.5.6 Brake System Encoder - BSE

EV.5.6.1 Refer to **T.4.3** for specific requirements of the BSE

EV.5.7 APPS / Brake Pedal Plausibility Check

EV.5.7.1 The power to the Motor(s) must be immediately and completely shut down when both of the following exist at the same time:

- The mechanical brakes are actuated
- The APPS signals more than 25% pedal travel

This must be demonstrated at Technical Inspection

EV.5.7.2 The Motor shut down must remain active until the APPS signals less than 5% pedal travel, with or without brake operation.

EV.5.8 Tractive System Part Positioning

All parts belonging to the Tractive System must meet **F.11**

EV.5.9 Housings and Enclosures

EV.5.9.1 Every housing or enclosure containing parts of the Tractive System other than Motor housings, must be labeled with the:

- a. Symbol specified in [ISO 7010-W012](#) (triangle with black lightning bolt on yellow background)
- b. Text “High Voltage” if the voltage meets **T.9.1.1**

EV.5.9.2 If the housing material is electrically conductive or possibly electrically conductive, it must have a low resistance connection to GLV System Ground, see **EV.7.7**

EV.5.10 Accumulator Hand Cart

EV.5.10.1 Teams must have a Hand Cart to transport their Accumulator Container(s).

EV.5.10.2 The Hand Cart must be used when the Accumulator Container(s) are transported on the competition site.

EV.5.10.3 Accumulator Container(s) must be securely attached to the Hand Cart

EV.5.10.4 The Hand Cart must:

- a. Be able to carry the load of the Accumulator Container(s) without tipping over
- b. Contain a minimum of two wheels
- c. Have a brake that must be:
 - Released only using a dead man type switch (where the brake is always on except when released by pushing and holding a handle)
 - Able to stop the Hand Cart with a fully loaded Accumulator Container

EV.6 ENERGY STORAGE

EV.6.1 Accumulator

EV.6.1.1 All cells or super capacitors which store the Tractive System energy are built into Accumulator Segments and must be enclosed in (an) Accumulator Container(s).

EV.6.1.2 Each Accumulator Segment must contain:

- Maximum static voltage of less than 120 V DC
- Maximum energy of 6 MJ

The contained energy of a stack is calculated by multiplying the maximum stack voltage with the nominal capacity of the used cell(s).

EV.6.1.3 No further energy storage except for reasonably sized intermediate circuit capacitors are allowed after the Energy Meter **EV.4.2**

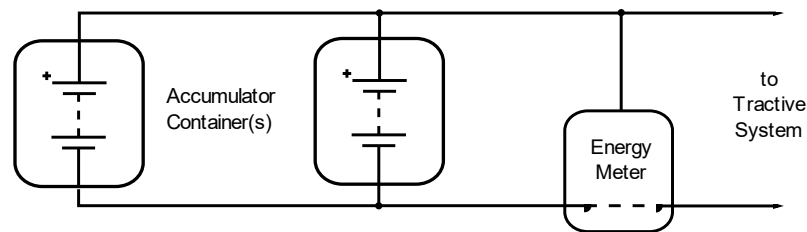

EV.6.1.4 All Accumulator Segments and/or Accumulator Containers (including spares and replacement parts) must be identical to the design documented in the ESF and SES

EV.6.2 Electrical Configuration

EV.6.2.1 All Tractive System components must be rated for the maximum Tractive System voltage

EV.6.2.2 If the Accumulator Container is made from an electrically conductive material:

- a. The poles of the Accumulator Segment(s) and/or cells must be isolated from the inner wall of the Accumulator Container with an insulating material that is rated for the maximum Tractive System voltage.
- b. All conductive surfaces on the outside of the Accumulator Container must have a low resistance connection to the GLV System Ground, see **EV.7.7**
- c. Any conductive penetrations, such as mounting hardware, must be protected against puncturing the insulating barrier.

EV.6.2.3 Each Accumulator Segment must be electrically insulated with suitable Nonflammable Material (**F.1.18**) (not air) between the segments in the container and on top of the segment.

The intent is to prevent arc flashes caused by inter segment contact or by parts/tools accidentally falling into the container during maintenance for example.

EV.6.2.4 Soldering electrical connections in the high current path is prohibited.

Soldering wires to cells for the voltage monitoring input of the AMS is allowed, these wires are not part of the high current path.

EV.6.2.5 Every wire used in an Accumulator Container, whether it is part of the GLV or Tractive System, must be rated to the maximum Tractive System voltage.

EV.6.3 Maintenance Plugs

EV.6.3.1 Maintenance Plugs must allow electrical separation of the Accumulator Segments to meet:

- a. The separated Segments meet voltage and energy limits of **EV.6.1.2**
- b. The separation must affect both poles of the Segment

EV.6.3.2 Maintenance Plugs must:

- a. Require the physical removal or separation of a component. Contactors or switches are not acceptable Maintenance Plugs
- b. Not be physically possible to connect in any configuration other than the design intended configuration
- c. Not require tools to install or remove
- d. Include a positive locking feature which prevents the plug from unintentionally becoming loose
- e. Be nonconductive on surfaces that do not provide any electrical connection

EV.6.3.3 When the Accumulator Containers are opened or Segments are removed, the Accumulator Segments must be separated by using the Maintenance Plugs. See **EV.10.2.1**

EV.6.4 Accumulator Isolation Relays - AIR

EV.6.4.1 Every Accumulator Container must contain minimum one fuse (**EV.7.6**) and two or more Accumulator Isolation Relays (AIR)

EV.6.4.2 The Accumulator Isolation Relays must:

- a. Be a Normally Open type
- b. Open both poles of the Accumulator

EV.6.4.3 When the AIRs are open, High Voltage **T.9.1.1** must not be present outside of the Accumulator Container.

EV.6.4.4 The Accumulator Isolation Relays and any fuses must be separated from the rest of the Accumulator with an electrically insulated and Nonflammable Material (**F.1.18**).

EV.6.4.5 A capacitor may be used to hold the AIRs closed for up to 250 ms after the Shutdown Circuit Opens **EV.8.2.2**

EV.6.5 High Voltage Disconnect - HVD

A High Voltage Disconnect (HVD) must be included to quickly disconnect one or both poles of the Accumulator **EV.10.1.2**

EV.6.5.1 The High Voltage Disconnect (HVD) must be:

- a. A directly accessible element, fuse or connector
- b. Above 350 mm from the ground
- c. Easily visible when standing behind the vehicle
- d. Operable in 10 seconds or less by an untrained person
- e. Operable without removing any bodywork or obstruction or using tools
- f. Directly operated. Remote operation through a long handle, rope or wire is not acceptable.
- g. Clearly marked with "HVD"

EV.6.5.2 An Interlock **EV.8.8** must Open the Shutdown Circuit **EV.8.2.2** when the HVD is removed

EV.6.5.3 A dummy connector or similar may be used to restore isolation to meet **EV.7.1.2**

EV.6.6 Precharge and Discharge Circuits

EV.6.6.1 The Accumulator must contain a Precharge Circuit. The Precharge Circuit must:

- a. Be able to charge the Intermediate Circuit to minimum 90% of the Accumulator voltage before closing the second AIR
- b. Be supplied from the Shutdown Circuit **EV.8.1**
- c. Not be fused

EV.6.6.2 The Intermediate Circuit must precharge before closing the second AIR. The end of precharge must be controlled by one of the following two options:

- a. Feedback by monitoring the voltage in the Intermediate Circuit
- b. A conservative time defined by the longer of:
 - Twice the time to charge to 90%
 - The time to charge to 90% plus 500ms

EV.6.6.3 The Tractive System must contain a Discharge Circuit. The Discharge Circuit must be:

- a. Wired in a way that it is always active when the Shutdown Circuit is open
- b. Able to discharge the Intermediate Circuit capacitors if the HVD has been opened
- c. Not be fused
- d. Designed to handle the maximum discharge current for minimum 15 seconds

EV.6.6.4 Positive Temperature Coefficient (PTC) devices must not be used to limit current for the Precharge Circuit or Discharge Circuit

EV.6.6.5 The precharge relay must be a mechanical type relay.

EV.6.7 Voltage Indicator

Each Accumulator Container must have a prominent indicator when High Voltage **T.9.1.1** is present at the vehicle side of the AIRs

EV.6.7.1 The Voltage Indicator must always function, including when the Accumulator Container is disconnected or removed

EV.6.7.2 The voltage being present at the connectors must directly control the Voltage Indicator using hard wired electronics with no software control.

EV.6.7.3 The control signal which closes the AIRs must not control the Voltage Indicator

EV.6.7.4 The Voltage Indicator must:

- a. Be located where it is clearly visible when connecting/disconnecting the Accumulator Tractive System connections
- b. Be labeled "High Voltage Present"

EV.6.8 Tractive System Measuring Points - TSMP

EV.6.8.1 Two Tractive System Measuring Points (TSMP) must be installed in the vehicle which are:

- a. Connected to the positive and negative motor controller/inverter supply lines
- b. Next to the Master Switches **EV.8.9**
- c. Protected by a nonconductive housing that can be opened without tools
- d. Protected from being touched with bare hands / fingers once the housing is opened

EV.6.8.2 Two TSMPs must be installed in the Charger **EV.9.2** which are:

- a. Connected to the positive and negative Charger output lines
- b. Available during charging of any Accumulator(s)

EV.6.8.3 The TSMPs must be:

- a. 4 mm shrouded banana jacks rated to an appropriate voltage level
- b. Color: Red
- c. Marked “HV+” and “HV-”

EV.6.8.4 Each TSMP must be secured with a current limiting resistor.

- a. The resistor must be sized per the following:

Maximum TS Voltage (Vmax)	Resistor Value
Vmax <= 200 V DC	5 kOhm
200 V DC < Vmax <= 400 V DC	10 kOhm
400 V DC < Vmax <= 600 V DC	15 kOhm

- b. Direct measurement of the value of the resistor must be possible during Electrical Technical Inspection.

EV.6.8.5 Any TSMP must not contain additional Overcurrent Protection.

EV.6.9 Tractive System Active Light - TSAL

EV.6.9.1 The vehicle must include a Tractive Systems Active Light (TSAL) that must:

- a. Illuminate when the GLV System is energized to indicate the status of the Tractive System
- b. Be directly controlled by the voltage present in the Tractive System using hard wired electronics. Software control is not permitted.
- c. Not perform any other functions.

EV.6.9.2 The TSAL may be composed of multiple lights inside a single housing

EV.6.9.3 When the voltage outside the Accumulator Container(s) exceeds **T.9.1.1**, the TSAL must:

- a. Be Color: Red
- b. Flash with a frequency between 2 Hz and 5 Hz

EV.6.9.4 When the voltage outside the Accumulator Container(s) is below **T.9.1.1**, the TSAL must:

- a. Be Color: Green
- b. Remain continuously illuminated

EV.6.9.5 The TSAL mounting location must:

- a. Be near the Main Hoop at the highest point of the vehicle.
- b. Be inside the **Rollover Protection Envelope F.1.13**
- c. Be no lower than 150 mm from the highest point of the Main Hoop.
- d. Not allow contact with the driver’s helmet in any circumstances.
- e. Not be in proximity to other lights.

EV.6.9.6 The TSAL must be visible:

- a. From every horizontal direction, except small angles which are blocked by the Main Hoop

- b. From a point 1.6 m vertically from ground level, inside a 3 m horizontal radius from the TSAL
- c. In direct sunlight

EV.6.10 Connectors

Tractive System connectors outside of a housing must meet one of the two:

- Contain an Interlock **EV.8.8** which must Open the Shutdown Circuit **EV.8.2.2**
- Be sealed at Tech Inspection **IN.4.7.1**

EV.7 ELECTRICAL SYSTEM

EV.7.1 Covers

EV.7.1.1 Nonconductive material or covers must prevent inadvertent human contact with any Tractive System voltage.

Covers must be secure and sufficiently rigid.

Removable Bodywork is not suitable to enclose Tractive System connections.

EV.7.1.2 Contact with any Tractive System connections with a 100 mm long, 6 mm diameter insulated test probe must not be possible when the Tractive System enclosures are in place.

EV.7.1.3 Tractive System components and Accumulator Containers must be protected from moisture, rain or puddles.

A rating of IP65 is recommended

EV.7.2 Insulation

EV.7.2.1 Insulation material must:

- a. Be appropriate for the expected surrounding temperatures
- b. Have a minimum temperature rating of 90°C

EV.7.2.2 Insulating tape or paint may be part of the insulation, but must not be the only insulation.

EV.7.3 Wiring

EV.7.3.1 All wires and terminals and other conductors used in the Tractive System must be sized for the continuous current they will conduct

EV.7.3.2 All Tractive System wiring must:

- a. Be marked with wire gauge, temperature rating and insulation voltage rating.
A serial number or a norm printed on the wire is sufficient if this serial number or norm is clearly bound to the wire characteristics for example by a data sheet.
- b. Have temperature rating greater than or equal to 90°C.

EV.7.3.3 Sizing of the conductors for the 'continuous Tractive System current' may consider the:

- a. RMS or average electrical current that will be used
- b. Anticipated duration of time at maximum electrical current

EV.7.3.4 Tractive System wiring must be:

- a. Done to professional standards with sufficient strain relief
- b. Protected from loosening due to vibration
- c. Protected against damage by rotating and / or moving parts

- d. Located out of the way of possible snagging or damage

EV.7.3.5 Any Tractive System wiring that runs outside of electrical enclosures:

- a. Must meet one of:
 - Enclosed in separate orange nonconductive conduit
 - Use an orange shielded cable.
- b. Must meet one of:
 - Run in a fully enclosed container. Bodywork is not an enclosure.
 - The conduit or shielded cable is securely anchored at each end to allow it to withstand a force of 200 N without straining the cable end crimp
- c. Any shielded cable must have the shield grounded.

EV.7.3.6 Wiring that is not part of the Tractive System must not use orange wiring or conduit.

EV.7.4 Connections

EV.7.4.1 All Tractive System connections must:

- a. Be designed to use intentional current paths through conductors such as copper or aluminum
- b. Not rely on steel bolts to be the primary conductor
- c. Not include compressible material such as plastic in the stack-up

EV.7.4.2 If external, uninsulated heat sinks are used, they must be properly grounded to the GLV System Ground, see [EV.7.7](#)

EV.7.4.3 All electrical connections, including bolts, nuts, and other fasteners, in the high current path of the Tractive System must be secured from unintentional loosening by the use of **Positive Locking Mechanisms** that are suitable for high temperatures.

Lock washers and thread locking compounds (Loctite®), DO NOT meet the positive locking requirement. Nyloc nuts do not meet the temperature requirements.

EV.7.4.4 When a Positive Locking Mechanism is required that cannot easily be inspected, information about this item must be presented at Electrical Technical Inspection

EV.7.5 Voltage Separation

EV.7.5.1 Separation of Tractive System and GLV System:

- a. The entire Tractive System and GLV System must be completely galvanically separated.
- b. The border between Tractive and GLV System is the galvanic isolation between both systems. Therefore, some components, such as the Motor Controller, may be part of both systems.

EV.7.5.2 There must be no connection between the Chassis of the vehicle (or any other conductive surface that might be inadvertently touched by a person), and any part of any Tractive System circuits.

EV.7.5.3 Tractive System and GLV circuits must not run through the same conduit or connector, except as allowed in [EV.8.8.4](#)

EV.7.5.4 GLV Systems other than the AIRs [EV.6.4](#), parts of the Precharge and Discharge Circuits [EV.6.6](#), HV DC/DC converters, the AMS [EV.8.3](#), the IMD [EV.8.6](#), parts of the TSAL [EV.6.9.1](#) the Energy Meter [EV.4.2](#) and cooling fans must not be inside the Accumulator Container.

EV.7.5.5 Where both Tractive System and GLV are included inside an enclosure, they must meet one of:

- a. Be separated by insulating barriers (in addition to the insulation on the wire) made of moisture resistant, UL recognized or equivalent insulating materials rated for 150° C or higher (such as Nomex based electrical insulation)
- b. Maintain the following spacing through air, or over a surface (similar to those defined in UL1741):

U < 100 V DC	10 mm
100 V DC < U < 200 V DC	20 mm
U > 200 V DC	30 mm

EV.7.5.6 Spacing must be clearly defined. Components and cables capable of movement must be positively restrained to maintain spacing.

EV.7.5.7 If Tractive System and GLV are on the same circuit board:

- a. They must be on separate, clearly defined and clearly marked areas of the board
- b. Required spacing related to the spacing between traces / board areas are as follows:

Voltage	Over Surface	Thru Air (cut in board)	Under Conformal Coating
0-50 V DC	1.6 mm	1.6 mm	1 mm
50-150 V DC	6.4 mm	3.2 mm	2 mm
150-300 V DC	9.5 mm	6.4 mm	3 mm
300-600 V DC	12.7 mm	9.5 mm	4 mm

EV.7.5.8 Teams must be prepared to demonstrate spacing on team built equipment.

For inaccessible circuitry, spare boards or appropriate photographs must be available for inspection.

EV.7.5.9 All connections to external devices such as laptops from a Tractive System component must include galvanic isolation.

EV.7.6 Overcurrent Protection

EV.7.6.1 All electrical systems (both Low Voltage and High Voltage) must have appropriate Overcurrent Protection/Fusing.

EV.7.6.2 Unless otherwise allowed in the Rules, all Overcurrent Protection devices must:

- a. Be rated for the highest voltage in the systems they protect.
Overcurrent Protection devices used for DC must be rated for DC and must carry a DC rating equal to or greater than the system voltage.
- b. Have a continuous current rating less than the continuous current rating of any electrical component that it protects.
- c. Have an interrupt current rating higher than the theoretical short circuit current of the system that it protects.

EV.7.6.3 Each parallel element of multiple parallel battery cells, capacitors, strings of battery cells, strings of capacitors, or conductors must have individual Overcurrent Protection.

EV.7.6.4 Any conductors (wires, busbars, etc) conducting the entire pack current must meet one of:

- a. Be appropriately sized for the total current that the individual Overcurrent Protection devices could transmit

- b. Contain additional Overcurrent Protection to protect the conductors

EV.7.6.5 Battery packs with Low Voltage or non voltage rated fusible links for cell connections may be used when all three conditions are met:

- An Overcurrent Protection device rated at a current three times lower than the sum of the parallel fusible links and complying with **EV.7.6.2.b above** is connected in series.
- The AMS can detect an open fusible link and will Open the Shutdown Circuit **EV.8.2.2** if a fault is detected.
- Fusible link current rating is specified in manufacturer's data or suitable test data is provided.

EV.7.6.6 Cells with internal Overcurrent Protection may be used without external Overcurrent Protection if suitably rated.

*Most cell internal Overcurrent Protection devices are Low Voltage or non voltage rated and conditions of **EV.7.6.5 above** will apply.*

EV.7.7 Grounding

EV.7.7.1 Parts of the vehicle which are 100 mm or less from any Tractive System component must have a resistance to GLV System Ground less than the values specified below.

- a. Electrically conductive parts 300 mOhms (measured with a current of 1 A)

Examples: parts made of steel, (anodized) aluminum, any other metal parts

- b. Parts which may become electrically conductive 5 Ohm

Example: carbon fiber parts

Carbon fiber parts may need special measures such as using copper mesh or similar to keep the ground resistance below 5 Ohms.

EV.7.7.2 Electrical conductivity of any part may be tested by checking any point which is likely to be conductive.

Where no convenient conductive point is available, an area of coating may be removed.

EV.8 SHUTDOWN SYSTEM

EV.8.1 Shutdown Circuit

EV.8.1.1 The Shutdown Circuit consists of the following components, connected in series:

- a. Accumulator Management System (AMS) **EV.8.3**
- b. Insulation Monitoring Device (IMD) **EV.8.6**
- c. Brake System Plausibility Device (BSPD) **EV.8.7**
- d. Interlocks (as required) **EV.8.8**
- e. Master Switches (GLVMS, TSMS) **EV.8.9**
- f. Shutdown Buttons **EV.8.10**
- g. Brake Over Travel Switch (BOTS) **T.3.2**
- h. Inertia Switch **T.9.4**

EV.8.1.2 The Shutdown Circuit must directly carry the current driving the Accumulator Isolation Relays (AIRs) and the Precharge Circuit Relay.

EV.8.1.3 The AMS, IMD, and BSPD parts of the Shutdown Circuit must be Normally Open contacts

EV.8.1.4 The AMS, IMD and BSPD must have completely independent circuits to Open the Shutdown Circuit.

The design of the respective circuits must ensure that a failure cannot result in electrical power being fed back into the Shutdown Circuit.

EV.8.1.5 The Shutdown Buttons, BOTS, TSMS, GLVMS and Interlocks must directly carry the Shutdown Circuit current

EV.8.1.6 The team must be able to demonstrate all features and functions of the Shutdown Circuit and components at Electrical Technical Inspection.

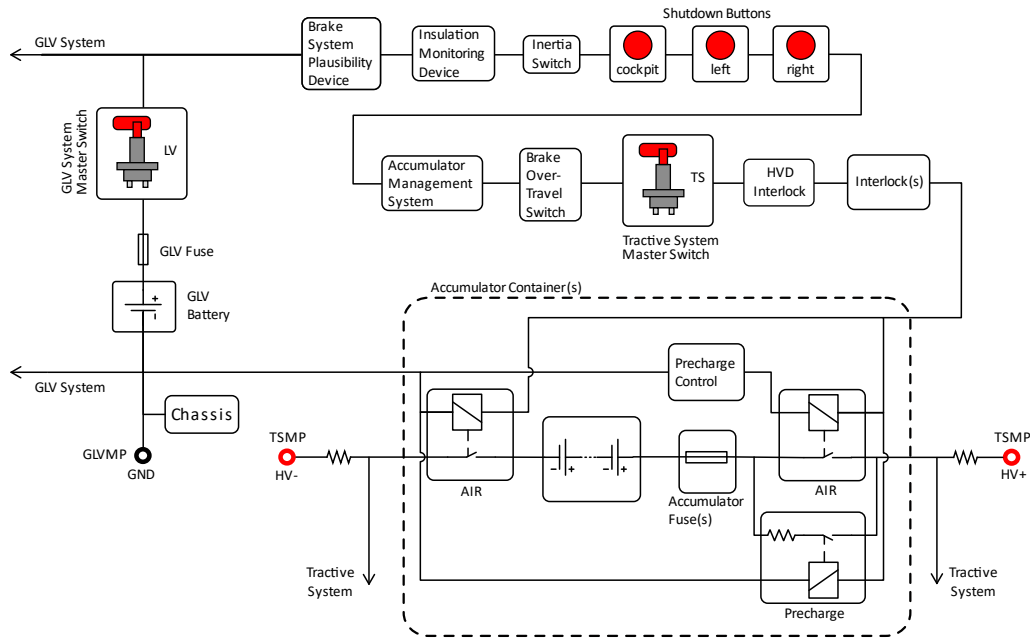

EV.8.2 Shutdown Circuit Operation

EV.8.2.1 The Shutdown Circuit must Open when any of the following exist:

- Operation of, or detection from any of the components listed in [EV.8.1.1](#)
- Any shutdown of the GLV System

EV.8.2.2 When the Shutdown Circuit Opens:

- The Tractive System must Shutdown
- All Accumulator current flow must stop immediately
- The voltage in the Tractive System must be Low Voltage [T.9.1.2](#) in five seconds or less
- The Motor(s) must spin free. No torque must be applied to the Motor(s)

EV.8.2.3 When the AMS, IMD or BSPD Open the Shutdown Circuit:

- The Tractive System must remain disabled until manually reset
- The driver must not be able to reactivate the Tractive System from inside the vehicle
- Operation of the Shutdown Buttons or TSMS must not reset the Shutdown Circuit
- The Tractive System must be reset only by manual action of a person directly at the vehicle.

EV.8.2.4 The driver may reset the Shutdown Circuit from the cockpit, subject to [EV.8.2.3](#)

EV.8.3 Accumulator Management System - AMS

EV.8.3.1 An Accumulator Management System must monitor the Accumulator(s) Voltage **EV.8.4** and Temperature **EV.8.5** when the:

- a. Tractive System is Active **EV.10.1**
- b. Accumulator is connected to a Charger **EV.9.3**

EV.8.3.2 The AMS must have galvanic isolation at every segment to segment boundary, as approved in the ESF

EV.8.3.3 Cell balancing is not permitted when the Shutdown Circuit is Open (**EV.8.2, EV.9.4**)

EV.8.3.4 The AMS must monitor for:

- a. Voltage values outside the allowable range **EV.8.4.2**
- b. Voltage sense Overcurrent Protection device(s) blown or tripped
- c. Temperature values outside the allowable range **EV.8.5.2**
- d. Missing or interrupted voltage or temperature measurements
- e. A fault in the AMS

EV.8.3.5 If the AMS detects one or more of the conditions of **EV.8.3.4 above**, the AMS must:

- a. Open the Shutdown Circuit **EV.8.2.2**
- b. Turn on the AMS Indicator Light

EV.8.3.6 The AMS Indicator Light must be:

- a. Color: Red
- b. Clearly visible to the seated driver in bright sunlight
- c. Clearly marked with the lettering "AMS"

EV.8.4 Accumulator Voltage

EV.8.4.1 The AMS must measure the cell voltage of every cell

When single cells are directly connected in parallel, only one voltage measurement is needed

EV.8.4.2 Cell Voltage levels must remain inside the allowed minimum and maximum cell voltage levels stated in the cell data sheet. Measurement accuracy must be considered.

EV.8.4.3 All voltage sense wires to the AMS must meet one of:

- a. Have Overcurrent Protection **EV.8.4.4 below**
- b. Meet requirements for no Overcurrent Protection listed in **EV.8.4.5 below**

EV.8.4.4 When used, Overcurrent Protection for the AMS voltage sense wires must meet the following.

- a. The Overcurrent Protection must occur in the conductor, wire or PCB trace which is directly connected to the cell tab.
- b. The voltage rating of the Overcurrent Protection must be equal to or greater than the smaller of:
 - The sum of the cell voltages sensed by the AMS board
 - The sum of the cell voltages sensed between galvanic isolation boundaries on the cell board/AMS

EV.8.4.5 Overcurrent Protection is not required on a voltage sense wire if all three of the following conditions are met:

- AMS is a distributed AMS system (one cell measurement per board)
- Sense wire length is < 25 mm
- AMS board has Overcurrent Protection

EV.8.5 Accumulator Temperature

EV.8.5.1 The AMS must measure the temperatures of critical points of the Accumulator

EV.8.5.2 Temperatures (considering measurement accuracy) must remain below the lower of the two:

- The maximum cell temperature limit stated in the cell data sheet
- 60°C

EV.8.5.3 Cell temperatures must be measured at the negative terminal of the respective cell

EV.8.5.4 The temperature sensor used must be in direct contact with one of:

- The negative terminal itself
- The negative terminal busbar less than 10 mm away from the cell terminal

EV.8.5.5 For lithium based cells,

- a. The temperature of a minimum of 20% of the cells must be monitored by the AMS
- b. The monitored cells must be equally distributed inside the Accumulator Container(s)

Every cell temperature should be monitored

EV.8.5.6 Multiple cells may be monitored with one temperature sensor, if **EV.8.5** is met for all cells sensed by the sensor.

EV.8.5.7 Temperature sensors must have appropriate electrical isolation that meets one of the two:

- Between the sensor and cell
- In the sensing circuit

The isolation must consider both GLV/TS isolation as well as common mode voltages between sense locations.

EV.8.6 Insulation Monitoring Device - IMD

EV.8.6.1 The vehicle must have an Insulation Monitoring Device (IMD) installed in the Tractive System.

EV.8.6.2 The IMD must be a Bender ISOMETER® IR155-3203 or IR155-3204 (refer to [website](#)) or equivalent IMD approved for automotive use.

EV.8.6.3 The response value of the IMD must be set to 500 Ohm / Volt or higher, related to the maximum Tractive System operation voltage.

EV.8.6.4 The IMD must monitor the Tractive System for:

- a. An isolation failure
- b. A failure in the IMD operation

This must be done without the influence of any programmable logic.

EV.8.6.5 If the IMD detects one or more of the conditions of **EV.8.6.4 above** the IMD must:

- a. Open the Shutdown Circuit **EV.8.2.2**
- b. Turn on the IMD Indicator Light

EV.8.6.6 The IMD Indicator Light must be:

- a. Color: Red
- b. Clearly visible to the seated driver in bright sunlight
- c. Clearly marked with the lettering “IMD”

EV.8.7 Brake System Plausibility Device - BSPD

EV.8.7.1 The vehicle must have a standalone nonprogrammable circuit to check for simultaneous braking and high power output

EV.8.7.2 The BSPD must be provided in addition to the **APPS / Brake Pedal Plausibility Check (EV.5.7)**

EV.8.7.3 The BSPD must Open the Shutdown Circuit **EV.8.2.2** when both of the following exist:

- Braking hard without locking the wheels
- Motor/Accumulator current is at a level where 5 kW of electrical power in the DC circuit is delivered to the Motors at the nominal battery voltage.

The BSPD may delay opening the shutdown circuit up to 0.5 sec to avoid false trips

EV.8.7.4 The BSPD must Open the Shutdown Circuit **EV.8.2.2** when there is an open or short circuit in any sensor input

EV.8.7.5 The team must have a test to demonstrate BSPD operation at Electrical Technical Inspection.

- a. Power must not be sent to the Motor(s) of the vehicle during the test
- b. The test must prove the function of the complete BSPD, including the current sensor

The suggested test would introduce a current by a separate wire from an external power supply simulating the Tractive System current while pressing the brake pedal

EV.8.8 Interlocks

EV.8.8.1 Interlocks must be incorporated where designated (refer to **EV.5.1.3, EV.6.5.2, EV.6.9**)

EV.8.8.2 Additional Interlocks may be included in the Tractive System or components

EV.8.8.3 The Interlock is a wire or connection that must:

- a. Open the Shutdown Circuit **EV.8.2.2** if the Interlock connection is broken or interrupted
- b. Not be in the low (ground) connection to the AIR coils of the Shutdown Circuit

EV.8.8.4 Interlock circuits or connections do not require physical separation from Tractive System wiring or components

EV.8.9 Master Switches

EV.8.9.1 Each vehicle must have two Master Switches that must:

- a. Meet **T.9.3** for Configuration and Location
- b. Be direct acting, not act through a relay or logic

EV.8.9.2 The Grounded Low Voltage Master Switch (GLVMS) must:

- a. Completely stop all power to the GLV System **EV.5.4**
- b. Be in the center of a completely red circular area of > 50 mm in diameter
- c. Be labeled “LV”

EV.8.9.3 The Tractive System Master Switch (TSMS) must:

- a. Open the Shutdown Circuit in the OFF position **EV.8.2.2**

- b. Be the last switch before the AIRs except for Precharge circuitry and Interlocks.
- c. Be in the center of a completely orange circular area of > 50 mm in diameter
- d. Be labeled "TS" and the symbol specified in [ISO 7010-W012](#) (triangle with black lightning bolt on yellow background).
- e. Be fitted with a "lockout/tagout" capability in the OFF position [EV.10.1.1](#)

EV.8.10 Shutdown Buttons

EV.8.10.1 Three Shutdown Buttons must be installed on the vehicle.

EV.8.10.2 Each Shutdown Button must be a push-pull or push-rotate emergency switch

EV.8.10.3 One Shutdown Button must be on each side of the vehicle which:

- a. Is located behind the driver's compartment at approximately the level of the driver's head
- b. Has a diameter of 40 mm minimum
- c. Must not be easily removable or mounted onto removable body work

EV.8.10.4 One Shutdown Button must be mounted in the cockpit which:

- a. Is located in easy reach of the belted in driver, adjacent to the steering wheel, and unobstructed by the steering wheel or any other part of the vehicle
- b. Has diameter of 24 mm minimum

EV.8.10.5 The international electrical symbol (a red spark on a white edged blue triangle) must be near each Shutdown Button.

EV.8.10.6 Pressing any of the Shutdown Buttons must Open the Shutdown Circuit [EV.8.2.2](#)

EV.9 CHARGER REQUIREMENTS

EV.9.1 Charger Requirements

EV.9.1.1 All features and functions of the Charger and Charging Shutdown Circuit must be demonstrated at Electrical Technical Inspection. [IN.4.1](#)

EV.9.1.2 Chargers will be sealed after approval. [IN.4.7.1](#)

EV.9.2 Charger Features

EV.9.2.1 The Charger must be galvanically isolated (AC) input to (DC) output.

EV.9.2.2 If the Charger housing is conductive it must be connected to the earth ground of the AC input.

EV.9.2.3 All connections of the Charger(s) must be isolated and covered.

EV.9.2.4 The Charger connector(s) must incorporate a feature to let the connector become live only when correctly connected to the Accumulator.

EV.9.2.5 High Voltage charging leads must be orange

EV.9.2.6 The Charger must have two TSMPs installed, see [EV.6.8.2](#)

EV.9.2.7 The Charger must include a Charger Shutdown Button which is:

- a. A push-pull or push-rotate emergency switch
- b. Minimum diameter of 25 mm
- c. Labelled with the international electrical symbol (a red spark on a white edged blue triangle)

EV.9.3 Charging Shutdown Circuit

EV.9.3.1 The Charging Shutdown Circuit consists of:

- a. Charger Shutdown Button **EV.9.2.7**
- b. Accumulator Management System (AMS) **EV.8.3**
- c. Insulation Monitoring Device (IMD) **EV.8.6**

EV.9.3.2 The AMS and IMD parts of the Charging Shutdown Circuit must:

- a. Be designed as Normally Open contacts
- b. Have completely independent circuits to Open the Charging Shutdown Circuit.
Design of the respective circuits must ensure that a failure cannot result in electrical power being fed back into the Charging Shutdown Circuit.

EV.9.4 Charging Shutdown Circuit Operation

EV.9.4.1 When Charging, the AMS and IMD must:

- a. Monitor the Accumulator
- b. Open the Charging Shutdown Circuit if a fault is detected.

EV.9.4.2 When the Charging Shutdown Circuit Opens:

- a. All current flow to the Accumulator must stop immediately
- b. The voltage in the Tractive System must be Low Voltage **T.9.1.2** in five seconds or less
- c. The Charger must be turned off
- d. The Charger must remain disabled until manually reset

EV.10 VEHICLE OPERATIONS

EV.10.1 Lockout

EV.10.1.1 The TSMS **EV.8.9.3** must be locked in the OFF position when any work is done on the vehicle.

EV.10.1.2 Until Electrical Inspection Completion **IN.4.7**, the HVD **EV.6.5** must be disconnected when vehicles are:

- a. Moved around the competition site
- b. Participating in Static Events

EV.10.2 Accumulator

EV.10.2.1 The following work activities at competition are allowed only in the designated area and during Electrical Technical Inspection **IN.4** See **EV.6.3.3**

- a. Opening Accumulator Containers
- b. Any work on Accumulators, cells, or Segments
- c. Energized electrical work

EV.10.2.2 Moving Accumulator cells and/or Accumulator Segment(s) at the competition site is only allowed inside a completely closed Accumulator Container. See **EV.5.10.2**

EV.10.3 Charging

EV.10.3.1 Accumulators must be removed from the vehicle inside the Accumulator Container and placed on the Accumulator Container Hand Cart **EV.5.10** for Charging.

EV.10.3.2 Accumulator Charging must occur only inside the designated area.

EV.10.3.3 A team member(s) who has knowledge of the Charging process must stay with the Accumulator(s) during Charging.

EV.10.3.4 Each Accumulator Container(s) must have a label with the following data during Charging: Team name and Electrical System Officer phone number(s).

EV.10.3.5 Additional site specific rules or policies may apply.

EV.10.4 Activation Sequence

The vehicle systems must energize in the following sequence:

EV.10.4.1 Low Voltage (GLV) System

- a. The Shutdown Circuit may be Closed when or after the GLV System is energized **EV.8.2.4**

EV.10.4.2 Tractive System Active

- a. Definition – High Voltage is present outside of the Accumulator Container
- b. Tractive System Active must not be possible until both:
 - GLV System is Energized
 - Shutdown Circuit is Closed

EV.10.4.3 Ready to Drive

- a. Definition – the Motor(s) will respond to the input of the APPS
- b. Ready to Drive must not be possible until:
 - Tractive System Active
 - The brake pedal is pressed and held to engage the mechanical brakes **T.3.1**
 - The driver performs a manual action to initiate Ready to Drive
Such as pressing a specific button in the cockpit

EV.10.5 Ready to Drive Sound

EV.10.5.1 The vehicle must make a characteristic sound when it is Ready to Drive

EV.10.5.2 The Ready to Drive Sound must be:

- a. Sounded continuously for minimum 1 second and a maximum of 3 seconds
- b. A minimum sound level of 80 dBA, fast weighting **IN.4.6**
- c. Easily recognizable. No animal voices, song parts or sounds that could be interpreted as offensive will be accepted

EV.10.5.3 The vehicle must not make other sounds similar to the Ready to Drive Sound.

IN - TECHNICAL INSPECTION

The objective of Technical Inspection is to determine if the vehicle meets the Formula SAE Rules requirements and restrictions and if, considered as a whole, it satisfies the intent of the Rules.

IN.1 INSPECTION REQUIREMENTS

IN.1.1 Inspection Required

Each vehicle must pass all applicable parts of Technical Inspection, receive Inspection Approval **IN.13.1** and show the Inspection Sticker **IN.13.2** before it may participate in any Dynamic event.

IN.1.2 Technical Inspection Authority

IN.1.2.1 The exact procedures and instruments used for inspection and testing are entirely at the discretion of the Chief Technical Inspector(s).

IN.1.2.2 Decisions of the Chief Technical Inspector(s) and the Organizer concerning vehicle compliance are final.

IN.1.3 Team Responsibility

Teams must make sure that their vehicle, and the required equipment, obeys the Formula SAE Rules before Technical Inspection.

IN.1.4 Reinspection

Officials may Reinspect any vehicle at any time during the competition **IN.15**

IN.2 INSPECTION CONDUCT

IN.2.1 Vehicle Condition

IN.2.1.1 Vehicles must be presented for Technical Inspection in finished condition, fully assembled, complete and ready to run.

IN.2.1.2 Technical inspectors will not inspect any vehicle presented for inspection in an unfinished state.

IN.2.2 Measurement

IN.2.2.1 Allowable dimensions are absolute, and do not have any tolerance unless specifically stated.

IN.2.2.2 Measurement tools and methods may vary.

IN.2.2.3 No allowance is given for measurement accuracy or error.

IN.2.3 Visible Access

All items on the Technical Inspection Form must be clearly visible to the technical inspectors without using instruments such as endoscopes or mirrors.

Methods to provide visible access include but are not limited to removable body panels, access panels, and other components

IN.2.4 Inspection Items

IN.2.4.1 Technical Inspection will examine all items included on the Technical Inspection Form to make sure the vehicle and other equipment obeys the Rules.

IN.2.4.2 Technical Inspectors may examine any other items at their discretion

IN.2.5 Correction

If any part of a vehicle does not comply with the rules, or is otherwise a concern, the team must:

- Correct the problem
- Continue Inspection or have the vehicle Reinspected

IN.2.6 Marked Items

IN.2.6.1 Officials may mark, seal, or designate items or areas which have been inspected to document the inspection and reduce the chance of tampering

IN.2.6.2 Damaged or lost marks or seals require Reinspection **IN.15**

IN.3 INITIAL INSPECTION

The following must be brought to Initial Inspection:

- Technical Inspection Form
- All Driver Equipment per **VE.3** to be used by each driver
- Fire Extinguishers (for paddock and vehicle) **VE.2.3**
- Wet Tires **V.4.3.2**

IN.4 ELECTRICAL TECHNICAL INSPECTION (EV ONLY)

IN.4.1 Inspection Items

The following must be brought to Electrical Technical Inspection:

- Charger(s) for the Accumulator(s) **EV.9.1**
- Accumulator Container Hand Cart **EV.5.10**
- Spare Accumulator(s) (if applicable) **EV.6.1.4**
- Electrical Systems Form (ESF) and Component Data Sheets **EV.2**
- Copies of any submitted Rules Questions with the received answer **GR.5**

The following basic tools in good condition:

- Insulated cable shears
- Insulated screw drivers
- Multimeter with protected probe tips
- Insulated tools, if screwed connections are used in the Tractive System
- Face Shield
- HV insulating gloves which are less than the test date
- Two HV insulating blankets of minimum 0.83 m² each
- Safety glasses with side shields for all team members that might work on the Tractive System or Accumulator

IN.4.2 Accumulator Inspection

The Accumulator(s) and associated equipment (Hand Cart, Chargers, etc) may be inspected during Electrical Technical Inspection, or separately from the rest of Electrical Technical Inspection.

IN.4.3 Accumulator Access

IN.4.3.1 If the Accumulator Container(s) is not easily accessible during Electrical Tech Inspection, detailed pictures of the internals taken during assembly must be provided.

IN.4.3.2 Tech inspectors may require access to check any Accumulators for rules compliance.

IN.4.4 Insulation Monitoring Device Test

IN.4.4.1 The Insulation Monitoring Device will be tested by connecting a resistor between the Tractive System Measuring Points (**EV.6.8**), and several electrically conductive vehicle parts while the Tractive System is active.

IN.4.4.2 The test is passed if the IMD shuts down the Tractive System in 30 seconds or less at a fault resistance of 50% below the response value corresponding to 250 Ohm / Volt.

IN.4.5 Insulation Measurement Test

IN.4.5.1 The insulation resistance between the Tractive System and GLV System Ground will be measured.

IN.4.5.2 The available measurement voltages are 250 V and 500 V. All vehicles with a maximum nominal operation voltage below 500 V will be measured with the next available voltage level. All teams with a system voltage of 500 V or more will be measured with 500 V.

IN.4.5.3 To pass the Insulation Measurement Test the measured insulation resistance must be minimum 500 Ohm/Volt related to the maximum nominal Tractive System operation voltage.

IN.4.6 Ready to Drive Sound

The sound level will be measured with a free field microphone placed free from obstructions in a radius of 2 m around the vehicle against the criteria in **EV.10.5**

IN.4.7 Electrical Inspection Completion

IN.4.7.1 All or portions of the Tractive System, Charger and other components may be sealed **IN.2.6**

IN.4.7.2 Additional monitoring to verify conformance to rules may be installed. Refer to the Event Website for further information.

IN.4.7.3 Electric Vehicles must pass Electrical Technical Inspection and Mechanical Technical Inspection before the vehicle may attempt any further Inspections. See **EV.10.1.2**

IN.5 DRIVER COCKPIT CHECKS

The Clearance Checks and Egress Test may be performed separately or in conjunction with other parts of Technical Inspection

IN.5.1 Driver Clearance

Helmet clearance per **F.5.6.3**, Head Restraint positioning per **T.2.8.5** and Harness fit and adjustment will be verified for each driver while in the normal driving position.

IN.5.2 Egress Test

IN.5.2.1 Each driver must be able to exit to the side of the vehicle in no more than 5 seconds.

IN.5.2.2 The Egress Test will be conducted for each driver as follows:

- a. The driver must wear the specified Driver Equipment **VE.3.2, VE.3.3**
- b. Egress time begins with the driver in the fully seated position, with hands in driving position on the connected steering wheel.

- c. Egress test may have the driver touch the (IC) Cockpit Main Switch **IC.9.4** (EV) Shutdown Button **EV.8.10.4**
- d. Egress time will stop when the driver has both feet on the pavement.

IN.5.3 Driver Clearance and Egress Test Completion

IN.5.3.1 In order to drive the vehicle, each team driver must:

- a. Meet the Driver Clearance requirements
- b. Successfully complete the Egress Test

IN.5.3.2 A driver(s) must complete the Driver Cockpit Checks to pass Mechanical Inspection

IN.6 DRIVER TEMPLATE INSPECTIONS

The Driver Template Inspection will be conducted as part of the Mechanical Inspection

IN.6.1 Conduct

The Driver Template shown in **F.5.6.4** will be positioned as given in **F.5.6.5**

IN.6.2 Driver Template Clearance Criteria

To pass Mechanical Technical Inspection, the specified clearance to the Driver Template must be met.

IN.7 COCKPIT TEMPLATE INSPECTIONS

The Cockpit Template Inspections will be conducted as part of the Mechanical Inspection

IN.7.1 Conduct

IN.7.1.1 The Cockpit Opening will be checked using the template and procedure given in **T.1.1**

IN.7.1.2 The Internal Cross Section will be checked using the template and procedure given in **T.1.2**

IN.7.2 Cockpit Template Criteria

To pass Mechanical Technical Inspection, both templates must fit as described.

IN.8 MECHANICAL TECHNICAL INSPECTION

IN.8.1 Inspection Items

The following items must be brought to Mechanical Technical Inspection:

- Vehicle on Dry Tires **V.4.3.1**
- Technical Inspection Form
- Push Bar **VE.2.2**
- Structural Equivalency Spreadsheet (SES) **F.2.1**
- Monocoque Laminate Test Specimens (if applicable) **F.4.3**
- The Impact Attenuator that was tested (if applicable) **F.8.7.7**
- Accumulator Container samples (EV only) (if applicable) **F.10.2.1.c**, **F.10.2.2.c**
- Tractive System Firewall sample (EV only) **T.1.9.2**
- Copies of any submitted Rules Questions with the received answer **GR.5**

IN.8.2 Aerodynamic Devices Stability and Strength

IN.8.2.1 Any Aerodynamic Devices may be checked by pushing on the device in any direction and at any point.

The following is guidance, but actual conformance will be up to technical inspectors at the respective competitions. The intent is to reduce the likelihood of wings detaching

IN.8.2.2 If any deflection is significant, then a force of approximately 200 N may be applied.

- a. Loaded deflection should not be more than 25 mm
- b. Any permanent deflection less than 5 mm

IN.8.2.3 If any vehicle on track is observed to have large, uncontrolled movements of Aerodynamic Devices, then officials may Black Flag the vehicle for **IN.15 Reinspection**.

IN.8.3 Monocoque Inspections

IN.8.3.1 Inspection Scope

The following items may be confirmed during inspection:

- a. Main hoop outer diameter and thickness where it protrudes above the monocoque
- b. Main hoop extends to the lowest part of the tub
- c. Mechanical attachment of main hoop to tub exists and matches the SES, at all points shown on the SES
- d. Front Hoop is installed, visually or by feel and that the mechanical attachment (if included) agrees with the SES

IN.8.3.2 When the Front Hoop is integrally bonded to the monocoque, the size and composition of the Front Hoop must be proven with:

- a. Documentation that shows dimensions on the tubes
- b. Pictures of the dimensioned tube being included in the layup

IN.8.3.3 For items which cannot be verified by an inspector, the team must provide documentation, visual and/or written, that the requirements have been met.

IN.8.3.4 A team found to be improperly presenting any evidence of the manufacturing process may be barred from competing with a monocoque.

IN.8.4 Engine Inspection (IC Only)

The organizer may measure or tear down engines to confirm conformance to the rules.

IN.8.5 Mechanical Inspection Completion

All vehicles must pass Mechanical Technical Inspection before a vehicle may attempt any further inspections.

IN.9 TILT TEST

IN.9.1 Tilt Test Requirements

- a. The vehicle must contain the maximum amount of fluids it may carry
- b. The tallest driver must be seated in the normal driving position
- c. Tilt tests may be conducted in one or the other, or both directions in order to pass
- d. (IC only) Engines fitted with mechanically actuated fuel pumps must be run to fill and pressure the system downstream of the High Pressure pump. See **IC.6.2**

IN.9.2 Tilt Test Criteria

IN.9.2.1 No fluid leakage of any type when the vehicle is tilted to a 45° angle to the horizontal

IN.9.2.2 Vehicle does not roll when tilted at an angle of 60° to the horizontal, corresponding to 1.7 g.

IN.9.3 Tilt Test Completion

Tilt Tests must be passed before a vehicle may attempt any further inspections

IN.10 NOISE AND SWITCH TEST (IC ONLY)

IN.10.1 Sound Level Measurement

IN.10.1.1 The sound level will be measured during a stationary test, with the vehicle gearbox in neutral at the defined Test Speed

IN.10.1.2 Measurements will be made with a free field microphone placed:

- free from obstructions
- at the exhaust outlet vertical level
- 0.5 m from the end of the exhaust outlet
- at an angle of 45° with the outlet in the horizontal plane (see [IN.10.2.2 below](#))

IN.10.2 Special Configurations

IN.10.2.1 Where more than one exhaust outlet is present, the test will be repeated for each exhaust and the highest reading will be used.

IN.10.2.2 Exhaust outlets that are not parallel to the ground may be tested outside of the horizontal plane.

IN.10.2.3 If the exhaust has any form of active tuning or throttling device or system, the exhaust must meet all requirements with the device or system in all positions.

IN.10.2.4 When the exhaust has a manually adjustable tuning device(s):

- a. The position of the device must be visible to the officials for the noise test
- b. The device must be manually operable by the officials during the noise test.
- c. The device must not be moved or modified after the noise test is passed.

IN.10.3 Industrial Engine

An engine which, according to the manufacturers' specifications and without the required restrictor, is capable of producing 5 hp per 100 cc or less.

- Submit a Rules Question to request approval of an Industrial Engine.

IN.10.4 Test Speeds

IN.10.4.1 Maximum Test Speed

The engine speed that corresponds to an average piston speed of:

- a. Automotive / Motorcycle engines 914.4 m/min (3,000 ft/min)
- b. Industrial Engines 731.5 m/min (2,400 ft/min)

The calculated speed will be rounded to the nearest 500 rpm.

Test Speeds for typical engines are published on the FSAE Online website.

IN.10.4.2 Idle Test Speed

- a. Determined by the vehicle's calibrated idle speed.
- b. If the idle speed varies then the vehicle will be tested across the range of idle speeds determined by the team.

IN.10.4.3 The vehicle must be compliant at all engine speeds up to the maximum defined Test Speed.

IN.10.5 Maximum Permitted Sound Level

- a. At idle 103 dBC, fast weighting
- b. At all other speeds 110 dBC, fast weighting

IN.10.6 Noise Level Retesting

IN.10.6.1 Noise levels may be monitored at any time.

IN.10.6.2 The Noise Test may be repeated at any time.

IN.10.7 Switch Function

The function of one or more of the Primary Master Switch **IC.9.3**, Cockpit Main Switch **IC.9.4**, and/or BOTS **T.3.2** will be verified during the Noise Test

IN.10.8 Noise Test Completion

Noise Tests must be passed before a vehicle may attempt any further inspections

IN.11 RAIN TEST (EV ONLY)

IN.11.1 Rain Test Requirements

- Tractive System must be Active
- The vehicle must not be in Ready to Drive mode (**EV.8**)
- Any driven wheels must not touch the ground
- A driver must not be seated in the vehicle

IN.11.2 Rain Test Conduct

The water spray will be rain like, not a direct high pressure water jet

- a. Water will be sprayed at the vehicle from any possible direction for 120 seconds
- b. The water spray will stop
- c. The vehicle will be observed for 120 seconds

IN.11.3 Rain Test Completion

The test is passed if the Insulation Monitoring Device (**EV.8.6**) does not react during the entire 240 seconds duration

IN.12 BRAKE TEST

IN.12.1 Objective

The brake system will be dynamically tested and must demonstrate the capability of locking all four wheels when stopping the vehicle in a straight line at the end of an acceleration run specified by the brake inspectors

IN.12.2 Brake Test Conduct (IC Only)

IN.12.2.1 Brake Test procedure:

- a. Accelerate to speed (typically getting into 2nd gear) until reaching the designated area
- b. Apply the brakes with force sufficient to demonstrate full lockup of all four wheels

IN.12.2.2 The Brake Test is passed when:

- All four wheels lock up
- The engine remains running during the complete test

IN.12.3 Brake Test Conduct (EV Only)

IN.12.3.1 Brake Test procedure:

- a. Accelerate to speed until reaching the designated area
- b. Switch off the Tractive System
- c. Apply the brakes with force sufficient to demonstrate full lockup of all four wheels

IN.12.3.2 The Brake Test is passed when all four wheels lock while the Tractive System is shut down

IN.12.3.3 The Tractive System Active Light may switch shortly after the vehicle has come to a complete stop as the reduction of the system voltage is not immediate. See [EV.8.2.2.c](#)

IN.13 INSPECTION APPROVAL

IN.13.1 Inspection Approval

IN.13.1.1 When all parts of Technical Inspection are complete as shown on the Technical Inspection sheet, the vehicle receives Inspection Approval

IN.13.1.2 The completed Inspection Sticker denotes the Inspection Approval

IN.13.1.3 The Inspection Approval is contingent on the vehicle remaining in the required condition throughout the competition.

IN.13.1.4 The Organizer, Chief Technical Inspector, or a designee may void Inspection Approval at any time for any reason

IN.13.2 Inspection Sticker

IN.13.2.1 Inspection Sticker(s) are issued following the completion of all or part of Technical Inspection

IN.13.2.2 Inspection Sticker(s) must show in the location given in [VE.1.4](#)

IN.13.3 Inspection Validity

IN.13.3.1 Inspection Stickers may be removed from vehicles that are not in compliance with the Rules or are required to be Reinspected.

IN.13.3.2 Inspection Approval is valid only for the duration of the specific Formula SAE competition during which the inspection is conducted.

IN.14 MODIFICATIONS AND REPAIRS

IN.14.1 Prior to Inspection Approval

Once the vehicle has been presented for judging in the Cost or Design Events, or submitted for Technical Inspection, and until the vehicle has the full Inspection Approval, the only modifications permitted to the vehicle are those directed by the Inspector(s) and noted on the Inspection Form.

IN.14.2 After Inspection Approval

IN.14.2.1 The vehicle must maintain all required specifications (including but not limited to ride height, suspension travel, braking capacity (pad material/composition), sound level and wing location) throughout the competition.

IN.14.2.2 Once the vehicle receives Inspection Approval, the ONLY modifications permitted to the vehicle are the following:

- Adjustment of belts, chains and clutches
- Adjustment of brake bias
- Adjustment of the driver restraint system, Head Restraint, seat and pedal assembly
- Substitution of the Head Restraint or seat insert for different drivers
- Adjustment to engine operating parameters, including fuel mixture and ignition timing, and any software calibration changes
- Adjustment of mirrors
- Adjustment of the suspension.
- Changing springs, sway bars and shims in the suspension
- Adjustment of Tire Pressure, subject to **V.4.3.4**
- Adjustment of wing or wing element(s) angle, but not the location **T.7.1**
- Replenishment of fluids
- Replacement of worn tires or brake pads. Replacement tires and brake pads must be identical in material/composition/size to those presented and approved at Technical Inspection.
- Changing of wheels and tires for weather conditions **D.6**
- Recharging Low Voltage batteries
- Recharging High Voltage Accumulators

IN.14.3 Repairs or Changes After Inspection Approval

The Inspection Approval may be voided for any reason including, but not limited to:

- a. Damage to the vehicle
- b. Changes beyond those allowed per **IN.14.2 above**

IN.15 REINSPECTION

IN.15.1 Requirement

IN.15.1.1 Any vehicle may be Reinspected at any time for any reason

IN.15.1.2 Reinspection must be completed to restore Inspection Approval, if voided

IN.15.2 Conduct

IN.15.2.1 The Technical Inspection process may be repeated in entirety or in part

IN.15.2.2 Specific areas or items to be inspected are at the discretion of the Chief Technical Inspector

IN.15.3 Result

IN.15.3.1 With Voided Inspection Approval

Successful completion of Reinspection will restore Inspection Approval **IN.13.1**

IN.15.3.2 During Dynamic Events

- a. Issues found during Reinspection will void Inspection Approval
- b. Penalties may be applied to the Dynamic Events the vehicle has competed in
Applied penalties may include additional time added to event(s), loss of one or more fastest runs, up to DQ, subject to official discretion.

S - STATIC EVENTS

S.1 GENERAL STATIC

Presentation	75 points
Cost	100 points
Design	150 points
Total	325 points

S.2 PRESENTATION EVENT

S.2.1 Presentation Event Objective

The Presentation Event evaluates the team's ability to develop and deliver a comprehensive business, logistical, production, or technical case that will convince outside interests to invest in the team's concept.

S.2.2 Presentation Concept

S.2.2.1 The concept for the Presentation Event will be provided on the FSAE Online website.

S.2.2.2 The concept for the Presentation Event may change for each competition

S.2.2.3 The team presentation must meet the concept

S.2.2.4 The team presentation must relate specifically to the vehicle as entered in the competition

S.2.2.5 Teams should assume that the judges represent different areas, including engineering, production, marketing and finance, and may not all be engineers.

S.2.2.6 The presentation may be given in different settings, such as a conference room, a group meeting, or in conjunction with other Static Events. Specific details will be included in the Presentation Concept.

S.2.3 Presentation Schedule

Teams that fail to make their presentation during their assigned time period will receive zero points for the Presentation Event.

S.2.4 Presentation Submissions

S.2.4.1 The Presentation Concept may require information to be submitted prior to the event. Specific details will be included in the Presentation Concept.

S.2.4.2 Submissions may be graded as part of the Presentation Event score.

S.2.4.3 Pre event submissions will be subject to penalties imposed as given in section **DR - Document Requirements**.

S.2.5 Presentation Format

S.2.5.1 One or more team members will give the presentation to the judges.

S.2.5.2 All team members who will give any part of the presentation, or who will respond to judges' questions must be:

- In the presentation area when the presentation starts
- Introduced and identified to the judges.

S.2.5.3 Presentations will be time limited. The judges will stop any presentation exceeding the time limit.

- S.2.5.4 The presentation itself will not be interrupted by questions. Immediately following the presentation there may be a question and answer session.
- S.2.5.5 Only judges may ask questions. Only team members who meet **S.2.5.2** may answer questions.

S.2.6 Presentation Equipment

Teams planning to use data projectors, visual display devices (tablets, computers, etc.), or other communication means as part of their presentation must bring, or arrange for, their own equipment.

S.2.7 Evaluation Criteria

- S.2.7.1 Presentations will be evaluated on content, organization, visual aids, delivery and the team's response to the judges' questions.
- S.2.7.2 The actual quality of the prototype itself will not be considered as part of the presentation judging
- S.2.7.3 Presentation Judging Score Sheet – available at the FSAE Online website.

S.2.8 Presentation Event Scoring

- S.2.8.1 The Presentation Event score is based on the average of the scores of each judge.
- S.2.8.2 Scoring Term Definitions
 - Pmax - the highest score awarded to any team
 - Pyour - the score awarded to your team
- S.2.8.3 Presentation Score is given by
$$\text{PRESENTATION SCORE} = 75 \times \text{Pyour}/\text{Pmax}$$
- S.2.8.4 Presentation Event scoring may include normalizing the scores of different judging teams and scaling the final results.

S.3 COST AND MANUFACTURING EVENT

S.3.1 Cost Event Objective

The Cost and Manufacturing Event evaluates the ability of the team to consider budget and incorporate production considerations for production and efficiency.

Making tradeoff decisions between content and cost based on the performance of each part and assembly and accounting for each part and process to meet a budget is part of Project Management.

S.3.2 Cost Event Supplement

- a. Additional specific information on the Cost and Manufacturing Event, including explanation and requirements, is provided in the Formula SAE Cost Event Supplement document.
- b. The Formula SAE Cost Event Supplement must be used to properly complete the requirements of the Cost and Manufacturing Event.
- c. The [Formula SAE Cost Event Supplement](#) is available on the FSAE Online website

S.3.3 Cost Event Areas

- S.3.3.1 Cost Report
Preparation and submission of a report (the "Cost Report")

S.3.3.2 Event Day Discussion

Discussion at the Competition with the Cost Judges around the team's vehicle.

S.3.3.3 Cost Scenario

Teams will respond to a challenge related to cost or manufacturing of the vehicle.

S.3.4 Cost Report

S.3.4.1 The Cost Report must:

- a. List and cost every part on the vehicle using the standardized Cost Tables.
- b. Base the cost on the actual manufacturing technique used on the prototype.
Cast parts on the prototype must be cost as cast, and fabricated parts as fabricated, etc.
- c. Include Tooling Cost (welding jigs, molds, patterns and dies) for processes requiring it.
- d. Exclude R & D and capital expenditures (plant, machinery, hand tools and power tools).
- e. Include supporting documentation to allow officials to verify part costing

S.3.4.2 Generate and submit the Cost Report using the FSAE Online website, see **DR - Document Requirements**

S.3.5 Bill of Materials - BOM

S.3.5.1 The BOM is a list for every vehicle part, showing the relationships between the items.

- a. The overall vehicle is broken down into separate Systems
- b. Systems are made up of Assemblies
- c. Assemblies are made up of Parts
- d. Parts consist of Materials, Processes and Fasteners
- e. Tooling is associated with each Process that requires production tooling

S.3.5.2 Generate the eBOM file with the BOM data and the Cost Summary from the FSAE Online website

S.3.5.3 Use the format provided and submit the eBOM file as given in section **DR - Document Requirements**

S.3.6 Late Submission

Penalties for Late Submission of Cost Report and/or eBOM will be imposed as given in section **DR - Document Requirements**.

S.3.7 Cost Addendum

S.3.7.1 A supplement to the Cost Report that reflects any changes or corrections made after the submission of the Cost Report may be submitted.

S.3.7.2 The Cost Addendum must be submitted during Onsite Registration at the Event.

S.3.7.3 The Cost Addendum must follow the format as given in section **DR - Document Requirements**

S.3.7.4 Addenda apply only to the competition at which they are submitted.

S.3.7.5 A separate Cost Addendum may be submitted for every competition a vehicle attends.

S.3.7.6 Changes to the Cost Report in the Cost Addendum will incur additional cost:

- a. Added items will be cost at 125% of the table cost: + (1.25 x Cost)
- b. Removed items will be credited 75% of the table cost: - (0.75 x Cost)

S.3.8 Cost Tables

- S.3.8.1 All costs in the Cost Report must come from the standardized Cost Tables.
- S.3.8.2 If a team wishes to use any Parts, Processes or Materials not included in the tables, an Add Item Request must be submitted. See **S.3.10**

S.3.9 Make versus Buy

- S.3.9.1 Every part may be classified as Made or Bought.
Refer to the **Formula SAE Cost Event Supplement** for additional information
- S.3.9.2 If a team genuinely Makes a part listed on the table as a Bought part, they may alternatively cost it as a Made part only if a place holder entry is listed in the tables enabling them to do so.
- S.3.9.3 Any part which is normally purchased that is optionally shown as a Made part must have supporting documentation submitted to prove team manufacture.
- S.3.9.4 Teams costing Bought parts as Made parts will be penalized.

S.3.10 Add Item Request

- S.3.10.1 An Add Item Request must be submitted on the FSAE Online Website to add items to the Cost Tables for individual team requirements.
- S.3.10.2 After review, the item may be added to the Cost Table with an appropriate cost. It will then be available to all teams.

S.3.11 Public Cost Reports

- S.3.11.1 The competition organizers may publish all or part of the submitted Cost Reports.
- S.3.11.2 Cost Reports for a given competition season will not be published before the end of the calendar year. Support materials, such as technical drawings, will not be released.

S.3.12 Cost Report Penalties Process

- S.3.12.1 The following procedure will be used in determining penalties:
 - a. Penalty A will be calculated using procedure **Penalty Method A - Fixed Point Deductions**
 - b. Penalty B will be calculated using procedure **Penalty Method B – Adjusted Cost Additions**
 - c. The greater of the two penalties will be applied against the Cost Event score
 - Penalty A expressed in points will be deducted from the Cost Event score
 - Penalty B expressed in dollars will be added to the Adjusted Cost of the vehicle
- S.3.12.2 Any error that results in a team over reporting a cost in their Cost Report will not be further penalized.
- S.3.12.3 Any instance where a team's score benefits by an intentional or unintentional error on the part of the students will be corrected on a case by case basis.
- S.3.12.4 **Penalty Method A - Fixed Point Deductions**
 - a. From the Bill of Material, the Cost Judges will determine if all Parts and Processes have been included in the analysis.
 - b. In the case of any omission or error a penalty proportional to the BOM level of the error will be imposed:
 - Missing/inaccurate Material, Process, Fastener 1 point
 - Missing/inaccurate Part 3 point

- Missing/inaccurate Assembly 5 point

c. Each of the penalties listed above supersedes the previous penalty.

Example - if a point deduction is given for a missing Assembly, the missing Parts are ignored.

d. Differences other than those listed above will be deducted at the discretion of the Cost Judges.

S.3.12.5 Penalty Method B – Adjusted Cost Additions

- a. The table cost for the missing or incomplete items will be calculated from the standard Cost Tables.
- b. The penalty will be a value equal to twice the difference between the team cost and the correct cost for all items in error.

Penalty = 2 x (Table Cost – Team Reported Cost)

The table costs of all items in error are included in the calculation. A missing Assembly would include the price of all Parts, Materials, Processes and Fasteners making up the Assembly.

S.3.13 Event Day and Discussion

S.3.13.1 The team must present their vehicle at the designated time

S.3.13.2 The vehicle must have the tires and wheels declared as Dry Tires per **V.4.3.1** installed during Cost Event judging

S.3.13.3 Teams may be required to bring a copy of the Cost Report and Cost Addendum to Cost Judging

S.3.13.4 The Cost Judges will:

- a. Review whether the Cost Report accurately reflects the vehicle as presented
- b. Review the manufacturing feasibility of the vehicle
- c. Assess supporting documentation based on its quality, accuracy and thoroughness.
- d. Apply penalties for missing or incorrect information in the Cost Report compared to the vehicle presented at inspection.

S.3.14 Cost Audit

S.3.14.1 Teams may be selected for additional review to verify all processes and materials on their vehicle are in the Cost Report.

S.3.14.2 Adjustments from the Cost Audit will be included in the final scores

S.3.15 Cost Scenario

The specific scenario will be provided prior to the competition and will include additional detail of how it will be conducted.

S.3.16 Cost Event Scoring

S.3.16.1 Scoring Term Definitions

- Adjusted Cost – reported cost (incorporating Cost Addendum) plus adjustments and penalties
- P_{your} - the Adjusted Cost of your vehicle
- P_{min} - the Adjusted Cost of the lowest cost vehicle
- P_{max} - the Adjusted Cost of the highest cost vehicle

S.3.16.2 Price Score is given by

$$\text{Price Score} = 40 \times \frac{(\text{Pmax} / \text{Pyour}) - 1}{(\text{Pmax} / \text{Pmin}) - 1}$$

S.3.16.3 Cost Event Score is the Sum of:

- Price Score 40 points maximum
 - Discussion Score 40 points maximum
 - Scenario Score 20 points maximum
 - Penalty Points deducted from score, no limit
- for a Total Score of: 100 points maximum

S.4 DESIGN EVENT

S.4.1 Design Event Objective

S.4.1.1 The Design Event evaluates the engineering effort that went into the vehicle and how the engineering meets the intent of the market both in terms of vehicle performance and overall value.

S.4.1.2 The team and vehicle that illustrate the best use of engineering to meet the design goals, a cost effective high performance vehicle, and the best understanding of the design by the team members will win the Design Event.

S.4.1.3 Components and systems that are incorporated into the design as finished items are not evaluated as a student designed unit, but are assessed on the team's selection and application of that unit.

S.4.2 Design Documents

S.4.2.1 Teams must submit the Design Briefing, Design Spec Sheet and Vehicle Drawings

S.4.2.2 These Design Documents will be used for:

- Design Judge reviews prior to the Design Event
- Sorting teams into appropriate design groups based on the quality of their review.

S.4.2.3 Penalties for Late Submission of all or any one of the Design Documents will be imposed as given in section **DR - Document Requirements**

S.4.2.4 Teams that submit one or more Design Documents which do not represent a serious effort to comply with the requirements may be excluded from the Design Event or be awarded a lower score.

S.4.3 Design Briefing

S.4.3.1 The Design Briefing must use the template from the FSAE Online website.

S.4.3.2 Refer to the Design Briefing template for:

- a. Specific content requirements, areas and details
- b. Maximum slides that may be used per topic

S.4.3.3 Submit the Design Briefing as given in section **DR - Document Requirements**

S.4.4 Vehicle Drawings

S.4.4.1 The Vehicle Drawings must meet the following:

- a. Three view line drawings showing the vehicle, from the front, top, and side

- b. Each drawing must appear on a separate page
- c. May be manually or computer generated

S.4.4.2 Submit the Vehicle Drawings as given in section **DR - Document Requirements**

S.4.5 Design Spec Sheet

Use the format provided and submit the Design Spec Sheet as given in section **DR - Document Requirements**

The Design Judges realize that final design refinements and vehicle development may cause the submitted values to differ from those of the completed vehicle. For specifications that are subject to tuning, an anticipated range of values may be appropriate.

S.4.6 Vehicle Condition

S.4.6.1 Inspection Approval **IN.13.1.1** is not required prior to Design judging.

S.4.6.2 Vehicles must be presented for Design judging in finished condition, fully assembled, complete and ready to run.

S.4.6.3 The judges will not evaluate any vehicle that is presented at the Design event in what they consider to be an unfinished state.

S.4.6.4 Point penalties may be assessed for vehicles with obvious preparation issues

S.4.7 Support Material

S.4.7.1 Teams may bring to Design Judging any photographs, drawings, plans, charts, example components or other materials that they believe are needed to support the presentation of the vehicle and the discussion of their development process.

S.4.7.2 The available space in the Design Event judging area may be limited.

S.4.8 Judging Sequence

Design judging may be conducted in one or more phases.

Typical Design judging includes a first round review of all teams, then additional review of selected teams.

S.4.9 Judging Criteria

S.4.9.1 The Design Judges will:

- a. Evaluate the engineering effort based upon the team's Design Documents, discussion with the team, and an inspection of the vehicle
- b. Inspect the vehicle to determine if the design concepts are adequate and appropriate for the application (relative to the objectives stated in the rules).
- c. Deduct points if the team cannot adequately explain the engineering and construction of the vehicle

S.4.9.2 The Design Judges may assign a portion of the Design Event points to the Design Documents

S.4.9.3 Design Judging Score Sheets are available at the FSAE Online website.

S.4.10 Design Event Scoring

S.4.10.1 Scoring may range from 0 to 150 points, at the discretion of the Chief Design Judge

S.4.10.2 Penalty points may be applied to the Design score

S.4.10.3 Vehicles that are excluded from Design judging or refused judging will receive zero points for Design, and may receive penalty points.

D - DYNAMIC EVENTS

D.1 GENERAL DYNAMIC

D.1.1 Dynamic Events and Maximum Scores

Acceleration	100 points
Skid Pad	75 points
Autocross	125 points
Efficiency	100 points
Endurance	275 points
Total	675 points

D.1.2 Definitions

D.1.2.1 **Dynamic Area** – Any designated portion(s) of the competition site where the vehicles may move under their own power. This includes competition, inspection and practice areas.

D.1.2.2 **Staging Area** – Any area(s) inside the Dynamic Area prior to the entry to an event for the purpose of gathering those vehicles that are about to start.

D.2 PIT AND PADDOCK

D.2.1 Vehicle Movement

D.2.1.1 Outside of the Dynamic Area(s), vehicles must be pushed at a normal walking pace using the Push Bar (**VE.2.2**), with a driver in the cockpit and with another team member walking beside

D.2.1.2 The team may move the vehicle with

- a. All four wheels on the ground
- b. The rear wheels supported on dollies, by push bar mounted wheels.

The external wheels supporting the rear of the vehicle must be non pivoting so the vehicle travels only where the front wheels are steered. The driver must always be able to steer and brake the vehicle normally.

D.2.1.3 When the Push Bar is attached, the engine must remain off, unless authorized by the officials.

D.2.1.4 Vehicles must be Shutdown when being moved around the paddock.

D.2.1.5 Vehicles with wings must have two team members, one walking on each side of the vehicle when the vehicle is being pushed.

D.2.1.6 A 25 point penalty may be assessed for each violation.

D.2.2 Fueling and Charging

(IC only) Officials must conduct all fueling activities in the designated location.

(EV only) Accumulator charging must be done in the designated location

D.2.3 Powertrain Operation

In the paddock, (IC) Engines may be run or (EV) Tractive System may be Active if:

- a. The vehicle has passed Technical Inspection up to and including the Tilt Test
- b. The vehicle is supported on a stand
- c. The drive wheels are minimum 10 cm off the ground, or the drive wheels have been removed

D.3 DRIVING

D.3.1 Drivers Meetings – Attendance Required

All drivers for an event must attend the drivers meeting(s). The driver for an event will be disqualified if he/she does not attend the driver meeting for the event.

D.3.2 Dynamic Area Limitations

Refer to the Event Website or event handbook for specific information

D.3.2.1 The organizer may specify restrictions for the Dynamic Area. These could include limiting the number of team members and what may be brought into the area.

D.3.2.2 The organizer may specify additional restrictions for the Staging Area. These could include limiting the number of team members and what may be brought into the area.

D.3.2.3 The organizer may establish requirements for persons in the Dynamic Area, such as closed toe shoes or long pants.

D.3.3 Driving Under Power

D.3.3.1 Vehicles must move under their own power only when inside the designated Dynamic Area(s), unless otherwise directed by the officials.

D.3.3.2 Driving a vehicle outside of scheduled events or scheduled practice will result in a 200 point penalty for the first violation and disqualification for a second violation.

D.3.4 Driving Offsite - Prohibited

Teams found to have driven their vehicle at an offsite location during the period of the competition will be excluded from the competition.

D.3.5 Driver Equipment

D.3.5.1 All Driver Equipment and Harness must be worn by the driver anytime in the cockpit with:

- a. (IC) Engine running or (EV) Tractive System Active
- b. Anytime between starting a Dynamic run and finishing or abandoning that Dynamic run.

D.3.5.2 Removal of any Driver Equipment during a Dynamic event will result in Disqualification.

D.3.6 Starting

Auxiliary batteries must not be used once a vehicle has moved to the starting line of any event. See **IC.8.1**

D.3.7 Practice Area

D.3.7.1 A practice area for testing and tuning may be available

D.3.7.2 The practice area will be controlled and may only be used during the scheduled times

D.3.7.3 Vehicles using the practice area must have a complete Inspection Sticker

D.3.8 Instructions from Officials

Obey flags and hand signals from course marshals and officials immediately

D.3.9 Vehicle Integrity

Officials may revoke the Inspection Approval for any vehicle condition that could compromise vehicle integrity, compromise the track surface, or pose a potential hazard.

This could result in DNF or DQ of any Dynamic event.

D.3.10 Stalled & Disabled Vehicles

D.3.10.1 If a vehicle stalls and cannot restart without external assistance, or is damaged and not able to complete the run, it will be scored DNF for that run

D.3.10.2 Disabled vehicles will be cleared from the track by the track workers.

D.4 FLAGS

Any specific variations will be addressed at the drivers meeting.

D.4.1 Command Flags

D.4.1.1 Any Command Flag must be obeyed immediately and without question.

D.4.1.2 **Black Flag** - Pull into the Driver Change Area for discussion with the track officials. A time penalty may be assessed.

D.4.1.3 **Black Flag with Orange Dot** - Pull into the Driver Change Area for a mechanical inspection, something has been observed that needs closer inspection.

D.4.1.4 **Blue Flag** - Pull into the designated passing zone to be passed by a faster competitor. Obey the corner workers signals at the end of the passing zone to merge into competition.

D.4.1.5 **Checkered Flag** - Run has been completed. Exit the course at the designated point.

D.4.1.6 **Green Flag** – Approval to begin your run, enter the course under direction of the starter. If you stall the vehicle, please restart and await another Green Flag

D.4.1.7 **Red Flag** - Come to an immediate safe controlled stop on the course. Pull to the side of the course as much as possible to keep the course open. Follow corner worker directions.

D.4.1.8 **Yellow Flag (Stationary)** - Danger, SLOW DOWN, be prepared to take evasive action, something has happened beyond the flag station. NO PASSING unless directed by the corner workers.

D.4.1.9 **Yellow Flag (Waved)** - Great Danger, SLOW DOWN, evasive action is most likely required, BE PREPARED TO STOP, something has happened beyond the flag station, NO PASSING unless directed by the corner workers.

D.4.2 Informational Flags

D.4.2.1 An Information Flag communicates to the driver, but requires no specific action.

D.4.2.2 **Red and Yellow Striped Flag** - Something is on the racing surface that should not be there. Be prepared for evasive maneuvers to avoid the situation.

D.4.2.3 **White Flag** - There is a slow moving vehicle on the course. Be prepared to approach it at a cautious rate.

D.5 WEATHER CONDITIONS

D.5.1 Operating Adjustments

D.5.1.1 The organizer may alter the conduct and scoring of the competition based on weather conditions.

D.5.1.2 No adjustments will be made to times for running in differing Operating Conditions.

D.5.1.3 The minimum performance levels to score points may be adjusted by the Officials.

D.5.2 Operating Conditions

D.5.2.1 The following operating conditions will be recognized:

- **Dry**
- **Damp**
- **Wet**

D.5.2.2 The current operating condition will be decided by the Officials and may change at any time.

D.5.2.3 The current operating condition will be prominently displayed at the Dynamic Area, and may be communicated by other means.

D.6 TIRES AND TIRE CHANGES

D.6.1 Tire Requirements

D.6.1.1 Teams must run the tires allowed for each Operating Condition:

Operating Condition	Tires Allowed
Dry	Dry (V.4.3.1)
Damp	Dry or Wet
Wet	Wet (V.4.3.2)

D.6.1.2 When the operating condition is Damp, teams may change between Dry Tires and Wet Tires:

- a. Any time during the Acceleration, Skidpad, and Autocross Events
- b. Any time before starting their Endurance Event

D.6.2 Tire Changes during Endurance

D.6.2.1 All tire changes after a vehicle has received the Green flag to start the Endurance Event must take place in the Driver Change Area.

D.6.2.2 If the Operating Condition changes to Wet during Endurance, the track will be Red Flagged or vehicles will be Black Flagged and brought into the Driver Change Area

D.6.2.3 The allowed tire changes and associated conditions are given in the following tables.

Existing Operating Condition	Currently Running on:	Operating Condition Changed to:		
		Dry	Damp	Wet
Dry	Dry Tires	ok	A	B
Damp	Dry Tires	ok	A	B
Damp	Wet Tires	C	C	ok
Wet	Wet Tires	C	C	ok

	Requirement	Allowed at Driver Change?
A	may change from Dry to Wet	Yes
B	MUST change from Dry to Wet	Yes
C	may change from Wet to Dry	NO

D.6.2.4 Time allowed to change tires:

- a. Change to Wet Tires - Any time in excess of 10 minutes without driver change, or 13 minutes with Driver Change, will be added to the team's total time for Endurance

- b. Change to Dry Tires - The time used to change to Dry Tires will be added to the team's total time for Endurance

D.6.2.5 If the vehicle has a tire puncture,

- a. The wheel and tire may be replaced with an identical wheel and tire
- b. When the puncture is caused by track debris and not a result of component failure or the vehicle itself, the tire change time will not count towards the team's total time.

D.7 DRIVER LIMITATIONS

D.7.1 Three Event Limit

D.7.1.1 An individual team member may not drive in more than three events.

D.7.1.2 The Efficiency Event is considered a separate event although it is conducted simultaneously with the Endurance Event.

A minimum of four drivers are required to participate in all of the dynamic events.

D.8 DEFINITIONS

D.8.1.1 **DOO** - Cone is Down or Out when one or both:

- a. Cone has been knocked over (Down)
- b. The entire base of the cone lies outside the box marked around the cone in its undisturbed position (Out)

D.8.1.2 **DNF** - Did Not Finish – The team attempted a run, but did not complete it, or was not allowed to complete it

D.8.1.3 **DQ** - Disqualified - run(s) or event(s) no longer valid

D.8.1.4 **Gate** - The path between two cones through which the vehicle must pass. Two cones, one on each side of the course define a gate. Two sequential cones in a slalom define a gate.

D.8.1.5 **Entry Gate** -The path marked by cones which establishes the required path the vehicle must take to enter the course.

D.8.1.6 **Exit Gate** - The path marked by cones which establishes the required path the vehicle must take to exit the course.

D.8.1.7 **OC** – Off Course

- a. The vehicle did not pass through a gate in the required direction.
- b. The vehicle has all four wheels outside the course boundary as indicated by cones, edge marking or the edge of the paved surface.

Where more than one boundary indicator is used on the same course, the narrowest track will be used when determining Off Course penalties.

D.9 ACCELERATION EVENT

The Acceleration event evaluates the vehicle acceleration in a straight line on flat pavement.

D.9.1 Acceleration Layout

D.9.1.1 Course length will be 75 m from starting line to finish line

D.9.1.2 Course width will be minimum 4.9 m wide as measured between the inner edges of the bases of the course edge cones

D.9.1.3 Cones are placed along the course edges at intervals, approximately 6 m

D.9.1.4 Cone locations are not marked on the pavement

D.9.2 Acceleration Procedure

D.9.2.1 Each team may attempt up to four runs, using two drivers, limited to two runs for each driver

D.9.2.2 Runs with the first driver have priority

D.9.2.3 Each Acceleration run is performed as follows:

- a. The foremost part of the vehicle will be staged at 0.30 m behind the starting line
- b. A Green Flag or light signal will give the approval to begin the run
- c. Timing starts when the vehicle crosses the starting line
- d. Timing ends when the vehicle crosses the finish line

D.9.2.4 Each driver may return to the front of the staging line immediately after their first run to make a second run

D.9.3 Acceleration Penalties

D.9.3.1 Cones (DOO)

Two second penalty for each DOO (including entry and exit gate cones) on that run

D.9.3.2 Off Course (OC)

DNF for that run

D.9.4 Acceleration Scoring

D.9.4.1 Scoring Term Definitions:

- Corrected Time = Acceleration Run Time + (DOO * 2)
- T_{your} - the best Corrected Time for the team
- T_{min} - the lowest Corrected Time recorded for any team
- T_{max} - 150% of T_{min}

D.9.4.2 When T_{your} < T_{max}. the team score is determined as:

$$\text{Acceleration Score} = 95.5 \times \frac{(T_{\text{max}} / T_{\text{your}}) - 1}{(T_{\text{max}} / T_{\text{min}}) - 1} + 4.5$$

D.9.4.3 When T_{your} > T_{max} , Acceleration Score = 4.5

D.10 SKIDPAD EVENT

The Skidpad event measures the vehicle cornering ability on a flat surface while making a constant radius turn.

D.10.1 Skidpad Layout

D.10.1.1 Course Design

- Two pairs of concentric circles in a figure of eight pattern
- Centers of the circles 18.25 m apart
- Inner circles 15.25 m in diameter
- Outer circles 21.25 m in diameter
- Driving path the 3.0 m wide path between the inner and outer circles

D.10.1.2 Cone Placement

- Sixteen (16) pylons will be placed around the inside of each inner circle and thirteen (13) pylons will be positioned around the outside of each outer circle in the pattern shown in the Skidpad layout diagram.
- Each circle will be marked with a chalk line, inside the inner circle and outside the outer circle

The Skidpad layout diagram shows the circles for cone placement, not for course marking. Chalk lines are marked on the opposite side of the cones, outside the driving path

- Additional pylons will establish the entry and exit gates.
- A cone may be placed in the middle of the exit gate until the finish lap.

D.10.1.3 Course Operation

- Vehicles will enter and exit through gates on a 3.0 m wide path that is tangential to the circles where they meet.
- The line between the centers of the circles defines the start/stop line.
- A lap is defined as traveling around one of the circles from the start/stop line and returning to the start/stop line.

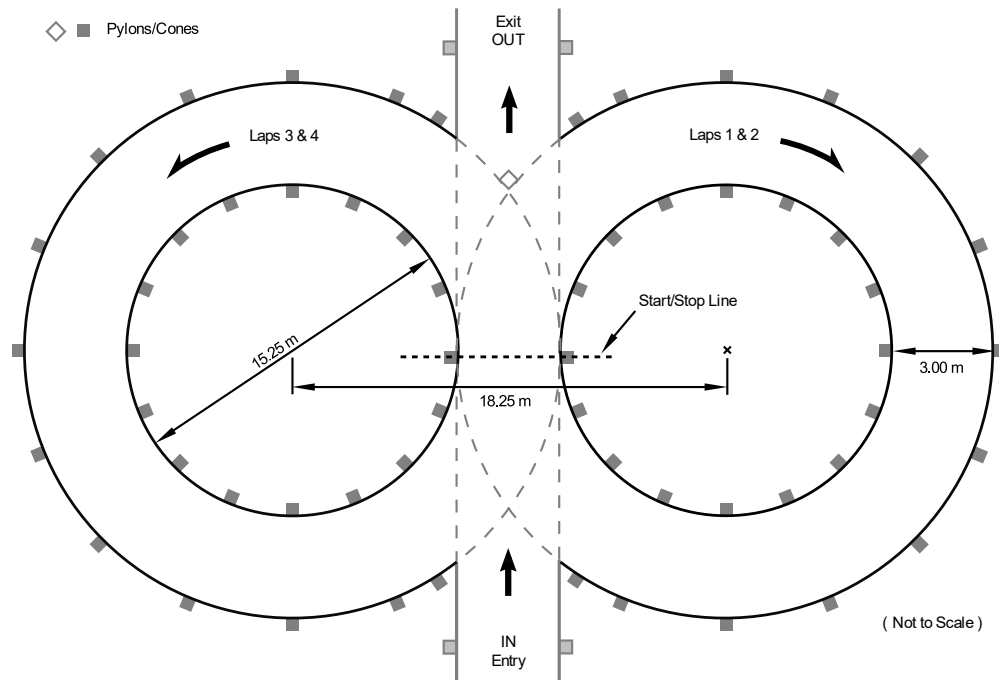

D.10.2 Skidpad Procedure

D.10.2.1 Each team may attempt up to four runs, using two drivers, limited to two runs for each driver.

D.10.2.2 Runs with the first driver have priority

D.10.2.3 Each Skidpad run is performed as follows:

- A Green Flag or light signal will give the approval to begin the run
- The vehicle will enter perpendicular to the figure eight and will take one full lap on the right circle
- The next lap will be on the right circle and will be timed

- d. Immediately following the second lap, the vehicle will enter the left circle for the third lap
- e. The fourth lap will be on the left circle and will be timed
- f. Immediately upon finishing the fourth lap, the vehicle will exit the track. The exit is at the intersection moving in the same direction as entered

D.10.2.4 Each driver may return to the front of the staging line immediately after their first run to make a second run

D.10.3 Skidpad Penalties

D.10.3.1 Cones (DOO)

A 0.125 second penalty for each DOO (including entry and exit gate cones) on that run

D.10.3.2 Off Course (OC)

DNF for that run. Vehicles that stall or spin out may continue if they have not gone Off Course.

D.10.3.3 Incorrect Laps

Vehicles that run an incorrect number of laps or run the laps in the wrong sequence will be DNF for that run.

D.10.4 Skidpad Scoring

D.10.4.1 Scoring Term Definitions

- Corrected Time = (Right Lap Time + Left Lap Time) / 2 + (DOO * 0.125)
- T_{your} - the best Corrected Time for the team
- T_{min} - is the lowest Corrected Time recorded for any team
- T_{max} - 125% of T_{min}

D.10.4.2 When T_{your} < T_{max}. the team score is determined as:

$$\text{Skidpad Score} = 71.5 \times \frac{(T_{\text{max}} / T_{\text{your}})^2 - 1}{(T_{\text{max}} / T_{\text{min}})^2 - 1} + 3.5$$

D.10.4.3 When T_{your} > T_{max} , Skidpad Score = 3.5

D.11 AUTOCROSS EVENT

The Autocross event evaluates the vehicle maneuverability and handling qualities on a tight course

D.11.1 Autocross Layout

D.11.1.1 The Autocross course will be designed with the following specifications. Average speeds should be 40 km/hr to 48 km/hr

- a. Straights: No longer than 60 m with hairpins at both ends
- b. Straights: No longer than 45 m with wide turns on the ends
- c. Constant Turns: 23 m to 45 m diameter
- d. Hairpin Turns: 9 m minimum outside diameter (of the turn)
- e. Slaloms: Cones in a straight line with 7.62 m to 12.19 m spacing
- f. Miscellaneous: Chicanes, multiple turns, decreasing radius turns, etc.

- g. Minimum track width: 3.5 m
- h. Length of each run should be approximately 0.80 km

D.11.1.2 The Autocross course specifications may deviate from the above to accommodate event site requirements.

D.11.2 Autocross Procedure

D.11.2.1 Each team may attempt up to four runs, using two drivers, limited to two runs for each driver

D.11.2.2 Runs with the first driver have priority

D.11.2.3 Each Autocross run is performed as follows:

- a. The vehicle will be staged at a specific distance behind the starting line
- b. A Green Flag or light signal will give the approval to begin the run
- c. Timing starts when the vehicle crosses the starting line
- d. Timing ends when the vehicle crosses the finish line

D.11.2.4 Each driver may return to the front of the staging line immediately after their first run to make a second run

D.11.3 Autocross Penalties

D.11.3.1 Cones (DOO)

Two second penalty for each DOO (including cones after the finish line) on that run

D.11.3.2 Off Course (OC)

- a. When an OC occurs, the driver must reenter the track at or prior to the point of exit or receive a 20 second penalty
- b. Penalties will not be assessed for accident avoidance or other reasons deemed sufficient by the track officials.

D.11.3.3 Missed Slalom

Missing one or more gates of a given slalom will be counted as one Off Course

D.11.4 Autocross Scoring

D.11.4.1 Scoring Term Definitions:

- Corrected Time = Autocross Run Time + (DOO * 2) + (OC * 20)
- T_{your} - the best Corrected Time for the team
- T_{min} - the lowest Corrected Time recorded for any team
- T_{max} - 145% of T_{min}

D.11.4.2 When T_{your} < T_{max}. the team score is determined as:

$$\text{Autocross Score} = 118.5 \times \frac{(T_{\text{max}} / T_{\text{your}}) - 1}{(T_{\text{max}} / T_{\text{min}}) - 1} + 6.5$$

D.11.4.3 When T_{your} > T_{max} , Autocross Score = 6.5

D.12 ENDURANCE EVENT

The Endurance event evaluates the overall performance of the vehicle and tests the durability and reliability.

D.12.1 Endurance General Information

- D.12.1.1 The organizer may establish one or more requirements to allow teams to compete in the Endurance event.
- D.12.1.2 Each team may attempt the Endurance event once.
- D.12.1.3 The Endurance event consists of two Endurance runs, each using a different driver, with a Driver Change between.
- D.12.1.4 Teams may not work on their vehicles once their Endurance event has started
- D.12.1.5 Multiple vehicles may be on the track at the same time
- D.12.1.6 Wheel to Wheel racing is prohibited.
- D.12.1.7 Vehicles must not be driven in reverse

D.12.2 Endurance Layout

- D.12.2.1 The Endurance event will consist of multiple laps over a closed course to a total distance of approximately 22 km.
- D.12.2.2 The Endurance course will be designed with the following specifications. Average speed should be 48 km/hr to 57 km/hr with top speeds of approximately 105 km/hr.
 - a. Straights: No longer than 77 m with hairpins at both ends
 - b. Straights: No longer than 61 m with wide turns on the ends
 - c. Constant Turns: 30 m to 54 m diameter
 - d. Hairpin Turns: 9 m minimum outside diameter (of the turn)
 - e. Slaloms: Cones in a straight line with 9 m to 15 m spacing
 - f. Miscellaneous: Chicanes, multiple turns, decreasing radius turns, etc.
 - g. Minimum track width: 4.5 m
 - h. Designated passing zones at several locations
- D.12.2.3 The Endurance course specifications may deviate from the above to accommodate event site requirements.

D.12.3 Endurance Run Order

The Endurance Run Order is established to let vehicles of similar speed potential be on track together to reduce the need for passing.

- D.12.3.1 The Endurance Run Order:
 - a. Should be primarily based on the Autocross event finish order
 - b. Should include the teams eligible for Endurance which did not compete in the Autocross event.
 - c. May be altered by the organizer to accommodate specific circumstances or event considerations
- D.12.3.2 Each team must keep track of the Endurance Run Order and have their vehicle fueled, in line and prepared to start when their turn to run arrives.

D.12.4 Endurance Vehicle Starting / Restarting

- D.12.4.1 Teams that are not ready to run or are unable to start their Endurance event in the allowed time when their turn in the Run Order arrives:
 - a. Will receive a time penalty (**D.12.12.5**)

- b. May then run at the discretion of the Officials
- D.12.4.2 Following Driver Change, the vehicle will be allowed up to 120 seconds (two minutes) to (IC) restart the engine or to (EV) enable the Tractive System.
- a. The time will start when the driver first tries to restart the engine or to enable the Tractive System.
 - b. The time to attempt start / restart is not counted towards the Endurance time
- D.12.4.3 If a vehicle stalls on the track, it will be allowed one lap by the vehicle that is following it (approximately 60 seconds) to restart. This time counts toward the Endurance time.
- D.12.4.4 If starts / restarts are not accomplished in the above times, the vehicle may be DNF.

D.12.5 Endurance Event Procedure

- D.12.5.1 Vehicles will be staged per the Endurance Run Order
- D.12.5.2 Endurance Event sequence:
- a. The first driver will perform an Endurance Run per **D.12.6 below**
 - b. The Driver Change must then be performed per **D.12.8 below**
 - c. The second driver will perform an Endurance Run per **D.12.6 below**
- D.12.5.3 The Endurance Event is complete when both:
- the team has completed the specified number of laps
 - the second driver crosses the finish line

D.12.6 Endurance Run Procedure

- D.12.6.1 A Green Flag or light signal will give the approval to begin the run
- D.12.6.2 The driver will drive approximately half of the Endurance distance
- D.12.6.3 A Checkered Flag will be displayed
- D.12.6.4 The vehicle must exit the track into the Driver Change Area

D.12.7 Driver Change Limitations

- D.12.7.1 The team may bring only the following into the Driver Change Area:
- a. Three team members, including the driver or drivers
 - b. (EV Only) The three team members must consist of an ESO **EV.3.1.1** and two drivers.
 - c. Only the tools necessary adjust the vehicle to accommodate the second driver and/or change tires may be carried into this area by hand (no carts, tool chests etc.).
 - d. Each extra person entering the Driver Change Area: 20 point penalty
- D.12.7.2 The only work permitted during Driver Change is:
- a. Operation of Master Switches **IC.9.3**, **EV.8.9**, Main Switch **IC.9.4**, or Shutdown Buttons **EV.8.10**
 - b. Adjustments to accommodate the driver
 - c. Tire changes per **D.6.2**

D.12.8 Driver Change Procedure

- D.12.8.1 The Driver Change will be performed in this sequence:
- a. Vehicle will stop in Driver Change Area

- b. First Driver turns off the engine / Tractive System. Driver Change time starts.
- c. First Driver exits the vehicle
- d. Any necessary adjustments may be made to the vehicle to fit the Second Driver (harness, seat, pedals, head restraint) as allowed by **IN.14.2.2**
- e. Second Driver is secured in the vehicle.
- f. Second Driver is ready to start the engine / enable the Tractive System. Driver Change time stops.
- g. Second Driver receives permission to continue
- h. The vehicle engine is started or Tractive System enabled. See **D.12.4**
- i. The vehicle stages to go back onto course, at the direction of the event officials

D.12.8.2 Three minutes are allowed for the team to complete the Driver Change

- a. Any additional time for inspection of the vehicle and the Driver Equipment is not included in the Driver Change time
- b. Time in excess of the allowed will be added to the team Endurance time

D.12.8.3 The Driver Change Area will be placed where the timing system will see the Driver Change as a long lap which will be deleted from the total time.

D.12.9 Breakdowns & Stalls

D.12.9.1 If a vehicle breaks down or is unable to restart, it will be removed from the course by track workers and scored DNF

D.12.9.2 If a vehicle stalls, or ingests a cone, etc., it may be allowed to continue, subject to **D.12.1.4** and **D.12.4**

D.12.10 Endurance Event – Black Flags

D.12.10.1 A Black Flag will be shown at the designated location

D.12.10.2 The vehicle must pull into the Driver Change Area at the first opportunity

D.12.10.3 The amount of time spent in the Driver Change Area is at the discretion of the officials.

D.12.10.4 Driving Black Flag

- a. May be shown for any reason such as aggressive driving, failing to obey signals, not yielding for passing, not driving inside the designated course, etc.
- b. Course officials will discuss the situation with the driver
- c. The time spent in Black Flag or a time penalty may be included in the Endurance Run time.
- d. If not possible to impose a penalty by a stop under a Black Flag, (not enough laps left), or during post event review, officials may impose a penalty **D.14.2**

D.12.10.5 Mechanical Black Flag

- a. May be shown for any reason to question the vehicle condition
- b. Time spent off track is not included in the Endurance Run time.

D.12.10.6 Based on the inspection or discussion during a Black Flag period, the vehicle may not be allowed to continue the Endurance Run and will be scored DNF

D.12.11 Endurance Event – Passing

D.12.11.1 Passing during Endurance may only be done in the designated passing zones, under the control of the track officials.

D.12.11.2 Passing zones have two parallel lanes – a slow lane for the vehicles that are being passed and a fast lane for vehicles that are making a pass.

D.12.11.3 When a pass is to be made:

- a. A slower leading vehicle will receive a Blue Flag
- b. The slower vehicle must move into the slow lane and decelerate.
- c. The following faster vehicle will continue in the fast lane and make the pass.
- d. The vehicle that had been passed may reenter traffic only under the control of the passing zone exit flag.

D.12.11.4 Passing rules do not apply to vehicles that are passing disabled vehicles on the course or vehicles that have spun out and are not moving. When passing a disabled or off track vehicle, slow down, drive cautiously and be aware of all the vehicles and track workers in the area.

D.12.12 Endurance Penalties

D.12.12.1 Cones (DOO)

Two second penalty for each DOO (including cones after the finish line) on that run

D.12.12.2 Off Course (OC)

- a. When an OC occurs, the driver must reenter the track at or prior to the point of exit or receive a 20 second penalty
- b. Penalties will not be assessed for accident avoidance or other reasons deemed sufficient by the track officials.

D.12.12.3 Missed Slalom

Missing one or more gates of a given slalom will be counted as one Off Course

D.12.12.4 Penalties for Moving or Post Event Violations

- a. Black Flag penalties per **D.12.10**, if applicable
- b. Post Event Inspection penalties per **D.14.2**, if applicable

D.12.12.5 Endurance Starting (**D.12.4.1**)

Two minutes (120 seconds) penalty

D.12.12.6 Vehicle Operation

The Chief Marshall/Director of Operations may end the Endurance event (DNF) a vehicle if, for any reason including driver inexperience or mechanical problems, it is too slow or being driven in a manner that demonstrates an inability to properly control.

D.12.13 Endurance Scoring

D.12.13.1 Scoring Term Definitions:

- Endurance Run Time - Total Time for both Drivers, minus the Driver Change lap, minus any Mechanical Black Flag Time, plus any Penalty time **D.14.2**
- Corrected Time = Endurance Run Time + (DOO * 2) + (OC * 20)
- T_{your} - the Corrected Time for the team
- T_{min} - the lowest Corrected Time recorded for any team

- T_{max} - 145% of T_{min}

D.12.13.2 The vehicle must complete the Endurance Event to receive a score based on their Corrected Time

- a. When $T_{your} < T_{max}$, the team score is determined as:

$$\text{Endurance Score} = 250 \times \frac{(T_{max} / T_{your}) - 1}{(T_{max} / T_{min}) - 1} + 25$$

- b. When $T_{your} > T_{max}$, Endurance Score = 25

D.12.13.3 When the vehicle does not complete Endurance (DNF), one point* is awarded per lap:

Endurance Score = Number of Completed Laps*

* Points per completed lap may be altered based on course length

D.13 EFFICIENCY EVENT

The Efficiency event evaluates the fuel/energy used to complete the Endurance event

D.13.1 Efficiency General Information

D.13.1.1 The Efficiency is based on a metric of the amount of fuel consumed or energy used and the lap time on the endurance course, averaged over the length of the event.

D.13.1.2 The Efficiency score is based only on the distance the vehicle runs on the course during the Endurance event, and the total fuel/energy used. No adjustment to distance or fuel/energy will be made.

D.13.2 Efficiency Procedure

D.13.2.1 For IC vehicles:

- The fuel tank must be filled to the fuel level line (**IC.5.4.5**)
- During fueling, once filled to the scribe line, no shaking or tilting of the tank, fuel system, or the entire vehicle is allowed.

D.13.2.2 (EV only) The vehicle may be fully charged

D.13.2.3 The vehicle will then compete in the Endurance event, refer to **D.12.5**

D.13.2.4 Vehicles must power down after leaving the course and be pushed to the fueling station or data download area

D.13.2.5 For IC vehicles:

- The fuel tank must be filled to the fuel level line (**IC.5.4.5**) to measure fuel used.
- Fuel pumps may be turned on and fuel valves may be opened to insure complete refuelling.
- If the fuel level changes after refuelling:
 - Additional fuel will be added to return the fuel tank level to the fuel level line.
 - Twice this amount will be added to the previously measured fuel consumption

D.13.2.6 (EV only) Energy meter data will be downloaded to determine energy used and check for power violations **EV.4.3**. Penalties will be applied per **EV.4.4**

D.13.3 Efficiency Eligibility

D.13.3.1 Maximum Time

Vehicles whose average Endurance laptime exceeds 1.45 times the average Endurance laptime of the fastest team that completes the Endurance event will receive zero points

D.13.3.2 Maximum Fuel/Energy Used

Vehicles whose corrected average fuel consumption per lap exceeds 26 liter/100 km or energy equivalent of 60.06 kgCO₂/100 km will receive zero points

D.13.3.3 Partial Completion of Endurance

- a. Vehicles which cross the start line following Driver Change are eligible for Efficiency points
- b. Other vehicles will receive a score of zero points

D.13.3.4 If damage or a potential environmental hazard (such as fuel tank leakage) exists, the fuel tank will not be refilled and the team will receive zero points for Efficiency

D.13.4 Efficiency Alternate Scoring (EV Only)

The organizer may decide to not measure Efficiency for Electric Vehicles that are run in their own class. When Efficiency is not measured:

- a. The decision will be communicated prior to the start of the Endurance event
- b. Each vehicle that is eligible for Efficiency points per **D.13.3** will be awarded full points for Efficiency

D.13.5 Efficiency Scoring

D.13.5.1 Conversion Factors

Each fuel or energy used is converted using the factors:

- a. Gasoline / Petrol 2.31 kg of CO₂ per liter
- b. E85 1.65 kg of CO₂ per liter
- c. Electric 0.65 kg of CO₂ per kWh

D.13.5.2 (EV only) Full credit will be given for energy recovered through regenerative braking

D.13.5.3 Scoring Term Definitions:

- CO₂ min - the smallest mass of CO₂ used by any competitor who is eligible for Efficiency
- CO₂ your - the mass of CO₂ used by the team being scored
- T_{min} - the lowest Endurance time of the fastest team which is eligible for Efficiency
- T_{your} - same as Endurance (**D.12.13.1**)
- Lap_{your} - the number of laps driven by the team being scored
- Lap_{total} T_{min} and Lap_{total} CO₂min - be the number of laps completed by the teams which set T_{min} and CO₂min, respectively

D.13.5.4 The Efficiency Factor is determined by:

$$\text{Efficiency Factor} = \frac{T_{\min} / \text{LapTotal } T_{\min}}{T_{\text{your}} / \text{Lap } T_{\text{your}}} \times \frac{\text{CO}_2 \text{ min} / \text{LapTotal } \text{CO}_2 \text{ min}}{\text{CO}_2 \text{ your} / \text{Lap } \text{CO}_2 \text{ your}}$$

D.13.5.5 EfficiencyFactor min will be calculated using the above formula with:

- CO₂ your equivalent to 60.06 kg CO₂/100km
- T_{your} 1.45 times T_{min}

D.13.5.6 When the team is eligible for Efficiency. the team score is determined as:

$$\text{Efficiency Score} = 100 \times \frac{(\text{Efficiency Factor min} / \text{Efficiency Factor your}) - 1}{(\text{Efficiency Factor min} / \text{Efficiency Factor max}) - 1}$$

D.14 POST ENDURANCE

D.14.1 Technical Inspection Required

D.14.1.1 After Endurance and refuelling are completed, all vehicles must report to Technical Inspection.

D.14.1.2 Vehicles may then be subject to **IN.15 Reinspection**

D.14.2 Post Endurance Penalties

D.14.2.1 Penalties may be applied to the Endurance and/or Efficiency events based on:

- a. Infractions or issues during the Endurance Event (including **D.12.10.4.d**)
- b. Post Endurance Technical Inspection
- c. (EV only) Energy Meter violations **EV.4.3, EV.4.4.2**

D.14.2.2 Any imposed penalty will be at the discretion of the officials.

D.14.3 Post Endurance Penalty Guidelines

D.14.3.1 One or more minor violations (rules compliance, but no advantage to team): 15-30 sec

D.14.3.2 Violation which is a potential or actual performance advantage to team: 120-360 sec

D.14.3.3 Violation with potential or actual effect on safety or environment: 240 sec up to DNF or DQ

D.14.3.4 Team may be DNF or DQ for:

- a. Multiple violations involving safety, environment, or performance advantage
- b. A single substantial violation